

MERIT BADGE SERIES



ENGINEERING





How to Use This Pamphlet

The secret to successfully earning a merit badge is for you to use both the pamphlet and the suggestions of your counselor.

Your counselor can be as important to you as a coach is to an athlete. Use all of the resources your counselor can make available to you. This may be the best chance you will have to learn about this particular subject. Make it count.

If you or your counselor feels that any information in this pamphlet is incorrect, please let us know.

Please state your source of information.

Merit badge pamphlets are reprinted annually and requirements updated regularly. Your suggestions for improvement are welcome.

Who Pays for This Pamphlet?

This merit badge pamphlet is one in a series of more than 100 covering all kinds of hobby and career subjects. It is made available for you to buy as a service of the national and local councils of Scouting America. The costs of the development, writing, and editing of the merit badge pamphlets are paid for by Scouting America in order to bring you the best book at a reasonable price.

Send comments along with a brief statement about yourself to
Program Development Department
Scouting America • 1325 West Walnut Hill Lane • Irving, TX 75038 If you
prefer, you may send your comments to merit.badge@scouting.org



SCOUTING AMERICA
MERIT BADGE SERIES

ENGINEERING



"Enhancing our youths' competitive edge through merit badges"

Scouting  America.



35890
ISBN 978-0-8395-3376-4
©2025 Scouting America
2025 Printing



Requirements

Always check [scouting.org](https://www.scouting.org) for the latest requirements.







Contents

Introduction	9
What Does an Engineer Do?	15
The Different Fields of Engineering	23
How Does an Engineer Solve Problems?	39
Basic Engineering Concepts	51
Let's Do Engineering	63
Engineering as a Career	87
The Professional Engineer	92
Engineering Resources	94



Introduction

Engineers turn ideas into reality. For example, they will take the plans drawn on paper for an exciting new roller coaster—a design with loops, drops, and corkscrews—and figure out how to build it so that it will be fast, safe to ride, and affordable to build. Engineers devise all sorts of things, ranging from a tiny, low-cost battery for your cellphone to a gigantic dam across the mighty Yangtze River in China.

The work of engineers affects every part of our lives—at home, at school, and at work. We have engineers to thank when we use escalators at the shopping mall, watch TV on the latest flat-panel screen, or get scanned for disease with the latest imaging equipment at the hospital.

Engineering touches so many parts of our lives that it has been divided into many different specialties. Civil engineers create the dams, bridges, and roadways on which we rely every day. Mechanical engineers develop machines and engines. Software engineers create computer programs. Biomedical engineers develop new medical devices to help us live longer and healthier lives. Aerospace engineers develop new aircraft and spacecraft. Petroleum engineers help discover and extract new sources of oil. And that is just a short list of engineering specialties.



An engineer will use both science and technology to meet needs. Famous inventors like Thomas Edison, Alexander Graham Bell, Henry Ford, and Benjamin Franklin were not called engineers, but innovators like them have been turning ideas into useful products for centuries. Franklin's experiments with electricity are among his many accomplishments. Edison's first electric lightbulb dramatically changed American life. Bell's telephone changed the way we communicate with one another. Ford not only made an engineering contribution to the design of early automobiles, but also transformed manufacturing by introducing the assembly line concept.

A Little History

Engineering has been around for a long time. Here are just a few examples of the many amazing engineering feats of the past.



Pyramids at Giza

Great Pyramid of Giza.

In 2600 B.C., the ancient Egyptians began building the Great Pyramid of Giza, which was the tallest structure in the world for thousands of years afterward. The project took more than 20 years to complete and required the precise cutting and placement of more than 2 million blocks of stone.



Great Wall of China

Great Wall of China. In the third century B.C., the Chinese started building the Great Wall. It would not be completed for another 1,800 years. The wall stretches for 4,000 miles across northern China, averaging 25 feet high and 15 to 30 feet wide at the base.

Taj Mahal. The Taj Mahal was completed in Agra, India, in 1654 as a monument to emperor Shah Jahan's wife. It is a complex of numerous structures, including a mausoleum, mosque, minarets, walls, watchtowers, and gardens.



Taj Mahal

The Royal Road. In the 1400s, the Incas of South America completed the Royal Road, a major roadway up to 52 feet wide that ran from what is now Santiago, Chile, to Quito, Ecuador. Until the late 1800s, it was the world's longest road. Parts of it crossed the Andes Mountains at elevations of almost 12,000 feet.

The builders of these ancient wonders used many of the same principles that modern structural engineers apply, though they were limited to the knowledge and technology of their day. As time passed, and knowledge and technology advanced, marvels of engineering became even more impressive.

Modern Marvels

In 1994, the American Society of Civil Engineers came up with a list it called the "Seven Wonders of the Modern World," which amounted to the greatest civil engineering feats of the 20th century.

Channel Tunnel. This remarkable 31-mile-long tunnel runs under the English Channel, between England and France. For much of its length, the tunnel lies 130 feet below the ocean floor. Instead of explosives, engineers used huge tunnel-boring machines that cut through rock and removed debris. The Channel Tunnel consists of three linked, parallel tunnels—one for each direction of travel, and a service tunnel that runs in between.

Canada's National Tower. The CN Tower, standing 1,815 feet above the city of Toronto, Ontario, is the world's tallest freestanding (using no guy wires) building. Some 1,465 feet up the tower is the "Sky Pod," the highest observation deck in the world. From there, you can see up to 75 miles away. The CN Tower was built to withstand wind gusts of up to 250 mph.

CN Tower

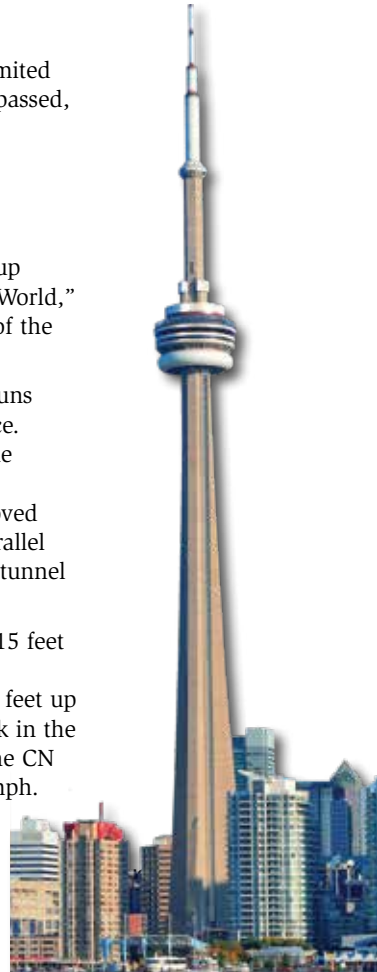



Empire State Building

Empire State Building. The first building in the world to have more than 100 floors was this 102-story skyscraper completed in New York City in 1931. For 41 years, it was the tallest skyscraper on Earth. The spire atop the 1,472-foot structure was originally designed to be a mooring mast for airships.



Golden Gate Bridge

Golden Gate Bridge. A beautiful 1.7-mile-long bridge in California, completed in 1937, spans the “Golden Gate” strait, which serves as the entrance to San Francisco Bay from the Pacific Ocean. The suspended-deck bridge uses tall towers and enormous cables to support the road surface below, which carries six lanes of traffic.



Itaipu Dam

Itaipu Dam. This 5-mile-wide dam, completed in 1982, spans the Parana River on the border of Brazil and Paraguay in South America. The Itaipu is the world's largest hollow gravity dam. A hollow gravity dam has empty chambers inside, making it cheaper to build, but still has enough mass to hold back water using its sheer weight. Until recently, the Itaipu was also the largest hydroelectric dam in the world.

Netherlands Delta Works. For centuries, the Dutch have fought to keep the sea at bay with levees (or dikes), seawalls, and water pumps powered by windmills. But large parts of the country fall below sea level. When a disastrous flood in 1953 killed more than 1,800 people, the nation undertook a huge engineering project to protect its citizens. It raised thousands of miles of dikes along the seashore and riverbanks, and built dams and storm surge barriers.

Panama Canal. This 48-mile ship canal, completed in 1914, connects the Atlantic and Pacific Oceans across the Isthmus of Panama in Central America. By linking the two oceans, the Panama Canal saves ships from having to travel thousands of extra miles if going around South America. Engineers devised a clever system of locks to raise ships from sea level up to the level of inland artificial lakes. After crossing the isthmus, boats are lowered back to sea level in another set of locks.

Panama Canal





What Does an Engineer Do?

Engineers work to solve problems. They may build roads or cars, design factories or computer games, or study traffic problems or the best way to make a chair. They find ways to make life easier, safer, and more productive by putting new knowledge and skills to work or by more efficiently using established methods and processes.

Engineering can be defined as the application of science, mathematics, technical knowledge, and practical experience to solve problems. The result is the design, creation, and operation of useful products, structures, machines, systems, and processes.

Creating better methods and products is important because, besides meeting people's needs more successfully, innovation also can save money. Engineers are always looking for ways to cut costs and improve efficiency. That allows companies to sell their products at a lower price, which stimulates competition and improves consumers' lives. For example, a typical desktop computer costs a third of the price it did 15 years ago.

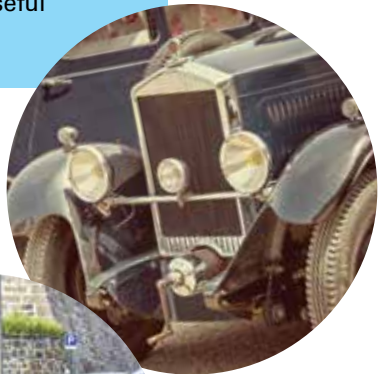

Engineering Today

For more about electronics and computers, see the *Electronics and Digital Technology* merit badge pamphlets.

Engineering breakthroughs don't happen only on a grand scale. Many innovations occur on a tiny scale—in a test tube or on a circuit board. The digital world we now live in took off with the invention of the transistor. This fingernail-sized switch and amplifier replaced the bulky glass vacuum tubes used in early radios and televisions. Suddenly these products could be smaller and less expensive and could be powered on batteries.

Over time, transistors were further miniaturized from hundreds to now millions of tiny transistors placed on a single integrated circuit. The integrated circuit made possible such products as the pocket calculator and digital wristwatch. Later, engineers designed the first microprocessor, putting all the circuits needed for a computer's central processing unit (its "brain") onto a single chip. This innovation made possible the personal computer, cellular telephone, and advanced missile technology.



Engineering innovations have advanced technology with lightning-quick speed. For example, which telephone do you think is more common these days?

Jack Kilby, Inventor of the Integrated Circuit

Jack Kilby (1923–2005), an electrical engineer, invented the integrated circuit in 1958 while working for Texas Instruments. Before then, electronic devices such as computers were made from individual transistors wired together to form circuits. Kilby had the idea of manufacturing multiple electronic components together on the same piece of semiconductor material, with all the connections built in—no soldering required. His invention paved the way for the development of modern computers and the Information Age of today.



Computers have also revolutionized how we communicate. In the 1960s, a network of computers was born that evolved into the Internet. Then, in 1990, a physicist named Tim Berners-Lee created the World Wide Web. His main innovations were the Uniform Resource Locator (URL), a form of address that can be used on any webpage or other file on the internet, and hypertext markup language (HTML), a form of computer language that creates webpages and links them to other webpages.

Engineering in Our Daily Lives

Besides being more fuel-efficient, cars today are much “cleaner”—they release fewer hazardous emissions into the air than those of years past.

Let’s look at the automobile. Thanks to the use of lighter and stronger materials and changes to engine designs, engineering improvements have made cars more fuel-efficient. In the 1950s and 1960s, the average car got 8 to 10 miles per gallon. Today’s automobiles go two or three times as far on the same amount of fuel.

Another significant engineering contribution is in automobile safety. Antilock brakes use speed sensors and hydraulic valves to slow each wheel independently to prevent skidding when the driver applies the brakes. A global positioning system (GPS) and cell-phone technology are combined in the OnStar tracking service offered by General Motors. If a car is in an accident, the system automatically signals service representatives who can summon ambulance and police responders. Improvements to car bumpers have reduced damage and injury by absorbing shock at low speeds.

In the home, programmable electronic thermostats automatically adjust heat and cold, saving hundreds of dollars in energy costs. Ovens with computerized timers automatically shut off the heating coils after the cooking time has elapsed. Electronic smoke sensors, wired together into one system, alert the whole family if a fire or smoke is detected. In some homes, security services will call for emergency assistance. Through the use of the internet and small cameras installed in the home, people can check up on their homes or loved ones from thousands of miles away.

Hybrid Cars: What Was Old Is New Again

Back in 1905, an American engineer named H. Piper filed the first patent application for a gas-electric hybrid car. Piper’s hybrid, and others like it, never caught on—that is, until the mid-1990s. Suddenly, worries about oil shortages and air pollution made hybrids attractive again. Modern hybrids get far better gas mileage than conventional cars. They use batteries to store electric power, and sometimes get by on the electric motor alone. What’s more, they cleverly capture the car’s kinetic energy (the energy of motion) through regenerative braking. Every time you apply the brakes, energy goes to the batteries to be stored.

Making Work Easier

As important as engineering is in the home, it is even more important in the workplace. Advances in engineering increase productivity, the amount of product that results from a given amount of energy or cost. Shaving just a few pennies off the cost of making a product—through better design or cheaper materials—could make the difference between profit and loss.

In factories, engineers can design systems and operating methods to reduce waste. They can devise specialized software to control production processes and manage inventory. They can help plan the best use of salespeople in the field and can design layouts for retail stores. They can even help set up storefronts on the internet, figure out how much product to keep in inventory, and decide how best to ship products.



Making Play More Fun

If you enjoy computer games, you can thank the software engineers for writing the code that makes those games possible. Likewise, hardware engineers design ever more advanced graphics chips and processors that make computer games appear sharper, more colorful, and more realistic.

Engineering has also affected the sports world. Bicycle engineers have developed better gear shifting for easier riding up hills, and lighter and stronger materials for bicycle frames and components. Tennis has also benefited from engineering improvements. Recent developments in racquet designs are resulting in a faster and more exciting game for tennis enthusiasts.



Understanding Electricity

Consumer electronics products like cellphones and laptop or tablet computers have become so popular that they are the basis of multibillion-dollar industries. These products demonstrate advanced electronics engineering, fitting sophisticated technology into very small packages.



The typical cellphone consists of a circuit board containing the electronic brains of the device, keyboard, antenna, display, speaker, microphone, camera, and battery, all of which fits inside a sturdy case not much bigger than the palm of your hand.

Cellphones use computer technology to handle the transmission of sound, images, video, and text. These are all forms of information that are either digital or can be converted to digital so that they can be encoded into radio waves sent between cellphones or from cellphones to computers via the internet. What our ears hear as sounds are vibrations or waves of air pressure that are not electrical. A microphone can “hear” such vibrations and convert them into analog electrical signals.

Cellphone processors convert such analog electrical signals from microphones into strings of digital ones and zeroes for transmission over radio waves and then, at the receiving phone or computer, the same kind of processor converts them back to analog so that speakers can make the final step of converting analog electrical signals to actual sound waves you can hear. Digital cameras in cellphones work much the same way but by sensing light instead of sound.

Light in the form of photons of different colors and intensities and arrangements are “seen” by photodetectors in the cellphone camera, which converts them into electrical signals that are transmitted between cellphones or computers digitally and reconstructed into images that are displayed by lighting up arrays of colored LEDs and LCDs on a display for us to see.



Your Turn

Give some thought to the above examples of engineering feats. Jot down a few of your own and see if you can suggest what might be possible in the future. Think about Scouting and the technological and engineering advancements that have affected it. There are many examples, such as camping gear and advances in first aid.



The Different Fields of Engineering

Each field of engineering applies different sciences, formulas, and techniques. Designing a bridge takes different knowledge than creating a fire hot enough to refine iron ore. The way an engineer figures out how to make large batches of chemicals is quite different from how another engineer plans to manufacture automobiles or computer chips.

The special scientific ideas and mathematical formulas needed by each type of engineer can be collected and made available to all the people doing that kind of work. These include information such as

- Tables that show how materials behave when cooled, heated, or melted
- Mathematical formulas that describe how air, water, or electrons flow
- Computer programs to help engineers understand how these things will happen



The First Engineering Specialties

Five early fields of engineering emerged to meet the growing needs of society that were brought about by the industrial revolution in the 1800s. These engineering fields were civil, mining and metallurgical, mechanical, chemical, and electrical.

Civil engineering specialties include structural engineering, transportation engineering, environmental engineering, hydraulic engineering, and surveying.



Civil Engineering

Civil engineers meet society's needs for infrastructure—things like roads, railways, bridges, dams, water supply systems, and sewage systems. A critical part of designing these structures is making sure they will stay where they are put—that they will not tilt, shift, or sink into the soil over time. Therefore, civil engineers often apply knowledge of geology and physics in their work.

The World's Largest Dam

In 2006, the largest dam in the world built to produce electricity was completed in China. The Three Gorges Dam stretches 1.4 miles across the massive Yangtze River. At 607 feet tall and constructed of some 21 million cubic yards of concrete, it is nearly five times as large as the famous Hoover Dam on the Arizona-Nevada border. The Three Gorges Dam will create a 410-mile-long reservoir up to 574 feet deep, eventually producing 18.2 gigawatts of power—about nine times as much as the Hoover Dam. The dam is expected to protect 15 million people from periodic flooding of the Yangtze River.





Brooklyn Bridge

John Roebling (1806–1869) developed a machine to create thin, flexible wire ropes that were twisted together to produce lengths up to 30,000 feet. These ropes were used to build New York City's Brooklyn Bridge and in projects such as the Panama Canal and San Francisco's Golden Gate Bridge.

Mining and Metallurgical Engineering

Mining and metallurgical engineers work to make mining and refining metals more predictable, safer, and less expensive. They do this by applying the principles of materials science—the study of the properties and behavior of solids, liquids, and gases.

Metallurgical engineers have advanced the ore refining processes by creating new mixtures (alloys) tailored to meet specific needs. Examples are hard metals that can hold a sharp edge, soft metals that can be stamped with artistic patterns, corrosion-resistant and weather-resistant metals, and metals that can withstand very high or very low temperatures. The metallurgist strives to meet the project's goals by delivering alloys with just the right properties in such areas as cost-effectiveness, weight, durability, and strength.

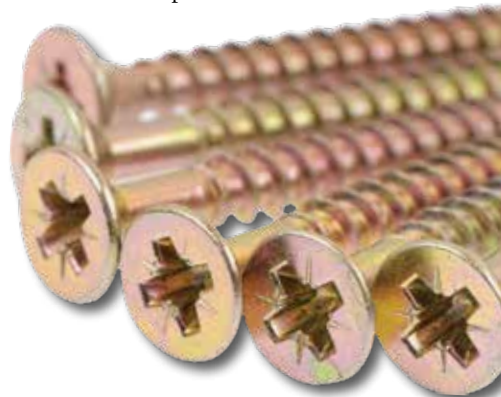

Presidential Engineers

Two U.S. presidents were engineers before they entered the White House. Herbert Hoover (1874–1964), the 31st president, had been a mining engineer and managed mines in Colorado, Australia, and China. He started his own engineering firm in 1908. In 1976, an engineer was elected as our nation’s 39th president. Jimmy Carter (1924–) studied nuclear physics at the U.S. Naval Academy in Annapolis, Maryland. Later, while serving in the Navy’s nuclear submarine program, he became a qualified nuclear engineer.



Mechanical Engineering

Mechanical engineers apply the principles of physics to design, build, and maintain mechanical systems. That can mean anything from designing a collapsible cardboard box for holding doughnuts to constructing the most advanced jet engines.



Potential energy is harnessed at hydroelectric power plants, where water drives a turbine and generator to create electricity.

Some mechanical engineers specialize in converting energy into more useful forms. Boilers and generators convert heat to electricity in coal-fired, gas-fired, and nuclear power plants. The energy in falling water can be used to generate electricity. Heat from the sun can be collected and used to heat water or even generate electricity.

Many mechanical engineers specialize in moving heat to where it is wanted and away from where it is not wanted. They design boilers, gasoline engines, and gas turbines (jet engines) that can operate for long periods without overheating, or fans to cool the microprocessors in computers.

Other mechanical engineers take the converted energy and devise machines to do useful things with it: Automobiles, lawn mowers, microengineered medical equipment, aircraft landing gears, and machines to mold plastic toys or fill soda bottles are all examples. These engineers learn how to use shafts and bearings, pulleys, gears, and mechanisms (collections of levers) to make things move around or back and forth or in special patterns, at specified speeds.

Two-Wheeled Marvel

The Segway[®] Personal Transporter (PT), a battery-powered, two-wheeled “human transporter,” is a marvel of engineering. What is amazing about the Segway PT is that it reacts to the rider’s movements, adjusting the speed of its wheels to maintain balance at all times. The rider leans forward to move the Segway PT ahead and backward to move in reverse. This ability to self-balance is accomplished by a combination of computers, motors, and gyroscopes.



Mechanical engineers understand how hard you can push on a part before it will bend or break, and how to design the shape of a part so that the lightest possible part will support the most force possible.

Chemical Engineering

Chemical engineers develop useful things based on the newest advances in chemistry. In the process, they harness their knowledge of chemicals, chemical reactions, and raw materials. When chemists create a new medicine, plastic, fiber, fabric, or glue, they normally make only a small amount in the laboratory. Chemical engineers devise ways to adapt these small laboratory experiments into full-scale productions in processing plants that can efficiently make tons of the new substance every day.

Electrical Engineering

Electrical engineers discover how to harness electricity to do more for people. They study and apply electronics and electromagnetism (the physics of electricity and magnetism).

Electrical engineering had its start during the latter part of the 19th century. The original focus was on generating and distributing electricity widely, to replace steam and water as sources of power and gas as a fuel for lighting. Along the way came inventions like electrically powered trains, microwave ovens, and other modern conveniences that have dramatically changed our lives, as well as communication devices that have brought people around the world closer together.

Electrical communications started with the telegraph before the Civil War, followed by the telephone (1876) and the radio (late 1800s). Television was first demonstrated in the United States in 1927. The transistor was invented in the late 1940s and showed up in portable radios by the late 1950s. Some of the earliest electronic computers were developed during World War II. The first modern digital computer, the ENIAC, was a giant machine that used vacuum tubes. The integrated circuits that make possible desktop computers were invented in the late 1950s, followed by the microprocessor and the first personal computers in the 1970s.



Inventing a Better Lightbulb

In 2006, engineering professor Shuji Nakamura was awarded the Millennium Technology Prize in part for inventing a type of solid state lighting that gives off light without generating heat. His light-emitting diodes use a fraction of the energy needed to brighten the filament inside Thomas Edison's incandescent lightbulb.

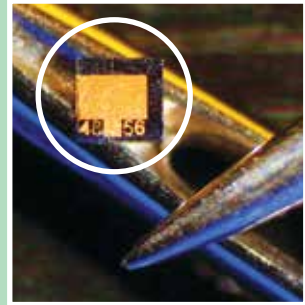

The specialties of modern electrical engineering include:

- Power generation and distribution
- Electrical machinery (motors and things run by motors)
- Communications (telephones, radio, TV, and data)
- Computer systems, sometimes called information systems
- Control systems (like those that guide robots)
- Electronic devices (integrated circuits, microprocessors)

Power Extremes

Some electrical engineers specialize in power: generating electricity, moving it across great distances to where it is needed, and delivering it to end users. They work with huge amounts of electricity, often at extremely high voltages.

Other electrical engineers work with low amounts of power. They design the microchips that go into computers and portable electronic devices. They can see the details of their work only under microscopes. Many of these fields are closely allied with other branches of science and engineering. For example, the turbines used to generate electricity are designed by mechanical engineers. The design of integrated circuits depends on materials scientists and engineers.



Today's Many Fields of Engineering

As technologies have become more complex and the products based on them more complicated, more modern engineering specialties have developed.



Aerospace Engineering. Aerospace engineers are specialized mechanical engineers that study the way airplanes and rockets interact with the air to fly; develop lightweight structures for airplanes and space vehicles; and design the high-powered engines needed to propel airplanes and lift space vehicles clear of Earth's gravity and atmosphere. Aerospace engineers specializing in aerodynamics design specially shaped wings, tails, and airplane bodies to move through the air with the least possible resistance.

Agricultural Engineering. Agricultural engineers design farm and food-processing equipment and develop systems for irrigation, drainage, and waste disposal. Some experiment with new ways to grow crops more efficiently, like hydroponics (growing plants without soil).



A horticulturist inspects the size and quality of hydroponically grown strawberries.

Architectural Engineering. Architectural engineers work with architects on the systems that make buildings functional, such as elevators and escalators, heating and cooling systems, and ventilation and air-conditioning systems. They also work with earth scientists to understand when, how, and at what strength natural forces—such as wind, rain, and earthquakes—will affect buildings.

Bioengineering. Bioengineering combines biology and engineering and also relies on the principles of biomechanics—the study of the mechanics (or workings) of living organisms. Bioengineers work with medical doctors to design surgical instruments, artificial organs like heart valves and hearts, implants to replace weakened bones, and prosthetics like artificial legs to help people who have been hurt in accidents.

World's First Bionic Man

Jesse Sullivan of Dayton, Tennessee, lost both of his arms in a terrible accident involving an electric power line. After recovering from his injuries, Mr. Sullivan was selected to receive a new type of artificial arm. This “bionic” arm is an improvement over earlier artificial limbs because the wearer can control it with his thoughts (a neural control) rather than by flexing certain muscles (a mechanical control). Now, when he thinks “close hand,” for example, impulses from his chest signal motors in his artificial limb, and his new hand closes.



Ceramic Engineering. Ceramic engineers work with processes that convert clay and nonmetallic minerals into ceramic products such as dishes, protective tiles for the space shuttle, and solar panels. During production, ceramic products are heated in very hot ovens, making them among the best materials for parts that will be exposed to high heat—such as inside a jet engine, or on the surface of a spaceship that must fly through the atmosphere to return to Earth.

Computer Engineering. The amazing rate at which computers have progressed is due in large part to computer engineers, who continue to find ways to make memory storage devices smaller, to fit more circuits on a microchip, and to move data faster and faster through the circuits. Devices for holding data and software programs, as well as media files such as photographs and movies, have exploded in capacity while their physical size has gotten smaller. The computer that controlled the lunar lander when Apollo astronauts landed on the moon in 1969 cost more than a million dollars. Today, the cheapest home computer has far more power than the Apollo computer—and costs a fraction of the price.

Environmental Engineering. Environmental engineers study the quality of the air, water, and land and develop systems to reduce pollution and help restore Earth to good health. Increasingly complex computer programs now allow environmental engineers to create computer models of the movement of air and pollutants. This lets engineers pinpoint the worst sources of pollution and how to improve air quality for the entire area. Once environmental engineers identify which polluting chemicals are coming out of the exhaust stack of a particular factory, for instance, they can design special equipment to clean up the exhaust and improve the air quality around that factory.

Industrial Engineering. Industrial engineers are concerned with how manufacturing plants are organized: what machinery there is, how materials and the things being made flow through the factory, and how people are organized to make the factory as effective as it can be. They often are involved in managing warehouse operations such as tracking inventory, routing conveyors, and overseeing materials handling. They use the branch of mathematics called statistics to design efficient systems.



Manufacturing Engineering. Mass-producing large quantities of products requires special knowledge of high-speed machinery (including automated machines and robots) to make sure the parts and finished products really are identical. This is the task of manufacturing engineers. They understand how machine tools cut metal, how tools wear out, and how assembly robots can consistently make good products day after day.

Marine or Naval Engineering. Just as special skills are needed to create vehicles that move through the air, designing ships also requires unique knowledge and mathematical tools. Marine or naval engineers design equipment for a structure that is constantly moving, twisting, and being slammed by environmental factors such as weather, salt water, current, and marine life.

Materials Engineering. Materials engineers work with all kinds of materials, natural and synthetic, to create new materials that meet specific needs for strength, flexibility, durability, and resistance to corrosion. Composites are excellent examples of what materials engineers are capable of creating. Composites can be strong enough for use as I beams or flexible enough to be formed into just about any shape, from airplane parts to bicycle frames.

A Comeback for Nuclear Power?

Nuclear power reactors generate electricity to run our homes, factories, and businesses. Interest in building new nuclear plants has grown with the rising cost of oil and natural gas and public concerns about air pollution caused by coal-burning power plants. Nuclear engineers are working to develop a new generation of reactors that would run at higher temperatures, drawing more power from the same amount of fuel—and also creating less radioactive waste.

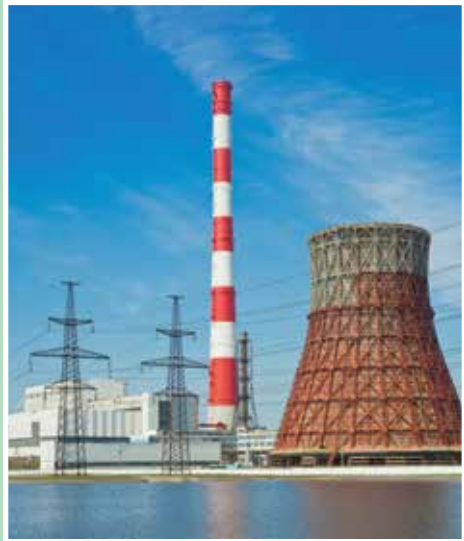

Nuclear Engineering. Nuclear engineers design systems that operate in the presence of nuclear radiation, from power plants to medical instruments to weapons. They specialize in applying materials that are not weakened by radiation, and in making the systems safe. Handling nuclear materials must be done safely and surely, whether the materials are tiny “seeds” to be implanted under the skin of a cancer patient, or new fuel supplies for a power plant. One task of nuclear engineers is to design containers that will safely shield the radiation under normal use, and will not break open if they are involved in an accident while they are being shipped.

Ocean Engineering. Some engineers say it is harder to work in the ocean than in outer space. Oceanic pressures are extremely high, temperatures vary greatly, unusual materials are found, and the wildlife ranges from Earth's tiniest animals to the largest known mammal. Ocean engineers design ways to harvest food from the ocean or harness the energy in waves. Some engineers are developing new methods and machines to make it possible to work and live beneath the sea for long periods.

The giant oil-drilling and pumping platforms that operate near America's Gulf Coast and in the stormy North Sea of northern Europe are complex and exciting ocean engineering projects. Engineers must design steady platforms that can withstand storms and occasional collisions by ships.



Today, we rely on petroleum for fuel as well as many nonfuel products, such as asphalt for roads, paint thinners, candy and chewing gum, and skin creams.

Petroleum Engineering. Petroleum engineers are specialized chemical engineers who develop efficient ways to extract crude petroleum from the ground. Near the coast of Southern California, oil-drilling rigs on the land actually branch out under the sea to find oil deposits. It is difficult and complex to drill more than a mile straight down into the earth. Can you imagine the extra engineering problems of drilling sideways?

Computer Tools

Many engineers today use computer tools to help them with their work. These computer-aided programs allow engineers to draw their design and then simulate how the design will work in many situations. CAD (computer-aided design) and CAE (computer-aided engineering) programs also allow engineers to make quick design changes and to simulate how designs operate without having to actually build the equipment.

Software Engineering. Software engineers apply the findings of computer science to design complex software systems and products—from the systems that control airplanes in flight, to the systems that watch over our money in banks, to exciting new computer games. They learn or create different programming languages to do different kinds of tasks. The fast-moving graphics action of a computer game is quite different from carrying out a detailed mathematical analysis. Creating photographlike images, complete with shadows and reflections, is different from searching a huge database for related items of information.

Systems Engineering. Complex systems like an airplane or a power plant require the expertise of many kinds of engineers. Systems engineers figure out how all the many parts of a complex system work together, so that a plane will fly safely or a power plant will generate power steadily, safely, and cleanly. Systems engineers often are the first engineers on a new project. They translate the customer's needs (like high-quality surround sound for a home-theater system) into requirements and specifications that other engineers can follow as they design the product. They then design tests to ensure that the finished product actually does what it was designed to do.

Besides the fields described above, there are other, more highly specialized fields of engineering. Engineers must be able to work in teams because many problems or projects are highly complex. Several specialties may be required to complete the project, and no one engineer may have all the necessary knowledge.



The Engineer's Work

Besides specializing in particular fields, different engineers have different responsibilities.

Design. The design engineer uses new and existing ideas to solve a new problem or to solve an old problem in a new way. These engineers find solutions that work according to the project's requirements, stay within the budget, and are easy and safe to use. The solutions must be doable, long-lasting, practical to maintain or repair, and environmentally safe.

Analysis. The analytical engineer is mainly responsible for creating mathematical models of physical problems. Analysis is the process of using the methods and tools of mathematics to simulate (mimic) how a physical object will behave in response to the forces acting upon it. The goal of analysis is to understand the object's behavior without the time and expense of building and testing physical models. Computer-aided engineering tools are used for simulation and analysis.

Testing. The test engineer develops and carries out tests of a new product to make sure it meets requirements for structural integrity, reliability, and performance under expected conditions. Also perform quality checks on existing products.

Industry Standards. Applying standards helps engineers to design compatible, safe, healthy, secure, and high-quality products. Standards influence the design of many everyday products. Phones, computers, cars, airplanes, and even road signs all are based upon industry standards. From sports to food, from transportation to buildings, standards help ensure compatibility between systems or products and aid in the adoption of new technology.

Research. Research engineers conduct research and seek out new materials, methods, and tools for other engineers to use. Together with research scientists, they explore advanced ideas and opportunities. Innovative products such as microrobots to help medical doctors in surgery, improved car aerodynamics (streamlining) to reduce drag and increase fuel efficiency, and computer microchips are direct results of research done by research engineers.

Sales. The sales engineer is a liaison (or go-between) between the company or organization that creates a product and the customers who use it. The sales engineer must understand the customer's needs as well as how the product or process works and why it will satisfy the customer's requirements. An outgoing personality and solid technical knowledge are important to be a successful sales engineer.

Management. Successful engineers with strong communication and leadership skills often become managers—project managers, department managers, chief engineers, engineering vice presidents—even presidents of companies and organizations. The role of the engineering management staff is to supervise the work of engineers assigned to them and ensure that projects are completed successfully, on time, and within budget.

Consulting. A consulting engineer is an independent, self-employed engineer who provides services to companies, organizations (including the government), or individual clients on a contract basis. A contract may be for one specific project or for long-term services. Consulting engineers serve in all fields of engineering, including management.

Teaching. An engineering professor is involved in teaching, research, and service. Teaching includes classroom teaching, supervising student research projects and papers, and developing courses for colleges and universities.

A Steadying Experience

Engineers often combine their training in one discipline with experience in other fields. One example is Wilson Greatbatch, who invented the heart pacemaker. Trained as an electrical engineer, Greatbatch worked in the areas of medicine, agriculture, and chemistry. He was building an oscillator to record heart sounds when he accidentally installed a resistor with the wrong resistance and it began to give off a steady electrical pulse. From this came the first implantable cardiac pacemaker, which has helped millions of people to live.

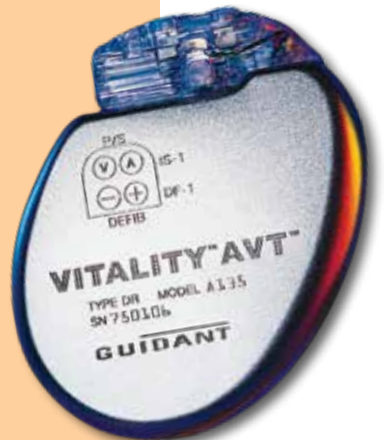

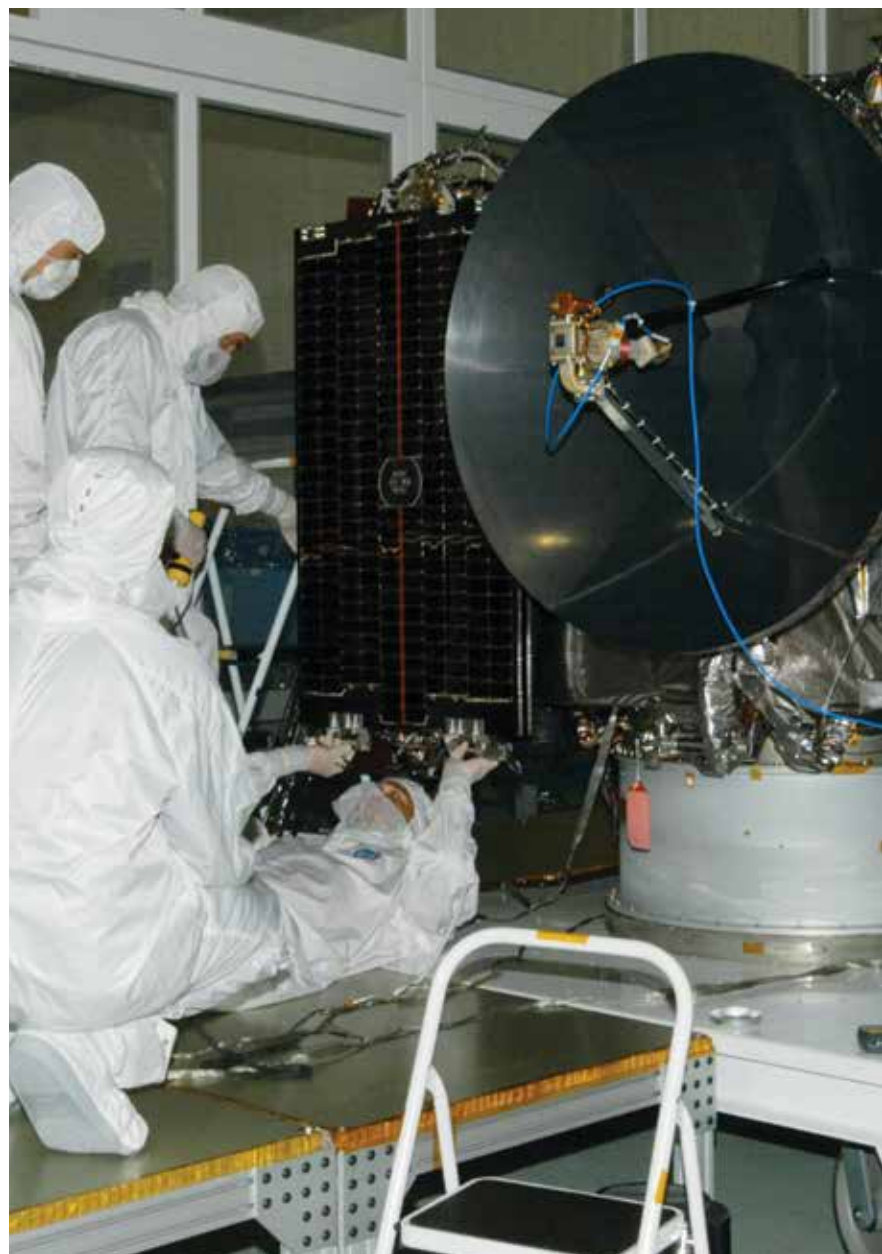

How Does an Engineer Solve Problems?

Think of problem solving as a complex, challenging game. As you solve the problem, you will find that several things must be done, and each of these things involves a new problem. We often call the main engineering problem to be solved a *project*.

Systems Engineering Approach to Problem Solving

You will use a systematic (planned or orderly) approach to accomplish your project. We call this approach *systems engineering*. There are nine steps to follow.

1. Establish a Systems Engineering Operation

As you set up your systems engineering operation, you will get an overview of the next eight steps of this approach. You will decide what items you will need to use, how you will make sketches or drawings, how you will analyze alternative designs, how you will make the parts you need, and how you will assemble and test the project.

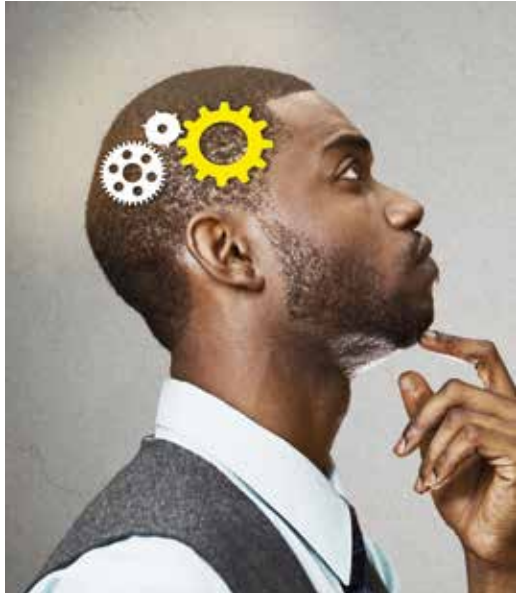

Note how these simple drawings for other projects differ from the sketch on page 43.

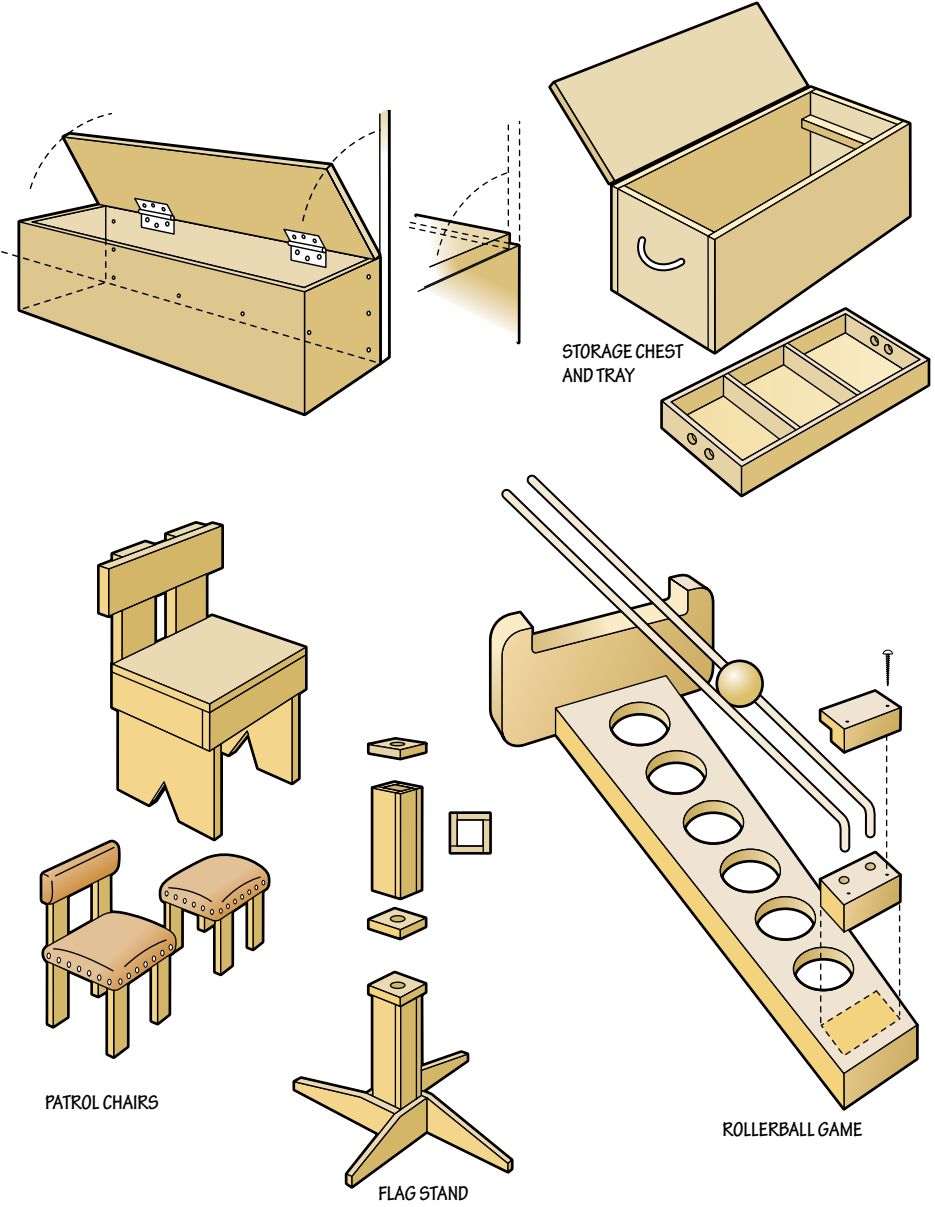

STORAGE CHEST AND TRAY

PATROL CHAIRS

FLAG STAND

ROLLERBALL GAME



Safety note: Use only power tools you are thoroughly familiar with and only under the direct supervision of a responsible adult who knows how to properly and safely operate those tools. The adult must always be present and aware of your task while you are operating a power tool.

List items you might need, such as a computer for computer-aided drafting, drafting tools, voltmeter, measuring scale, or hand tools. For example, let's assume you have the following items that you may use for projects:

- A set of wrenches for nuts and bolts
- Two or three each of straight-head and Phillips-head screwdrivers
- A socket wrench set
- A hammer and handsaw for wood
- A hacksaw for metal or plastic
- A ruler and a measuring tape
- Pencils, plastic triangles and templates, and a drafting compass for making drawings and sketches
- Electrical multimeter (ammeter and voltmeter) for electrical measurements
- A workbench with a vise for holding pieces
- Two C-clamps
- Various power hand tools, such as a drill motor (with a few drill bits) and a sander

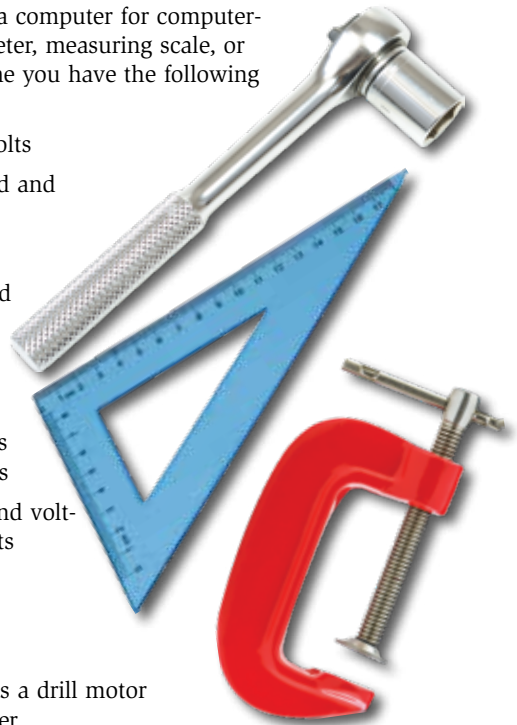

The tools listed above are the physical assets available to you for the manufacturing phase of your project. This project might be a freestanding patrol box for base camping. If the base camp has electrical power available, you might add a light to the design project. You have the multimeter to check the electrical system.

Next, make an outline of a milestone (or Gantt) chart. You will use this to schedule the steps required for the project. Here is a sample Gantt chart.

Example Gantt Chart: Patrol Box														
	Time Schedule—Project days from start													
Project Task	1	2	3	4	5	6	7	8	9	10	11	12	13	14
Project statement	█													
Planning	█	█	█	█	█									
Ideas		█	█	█	█	█								
Draw best ideas			█	█	█	█	█							
Analyze ideas				█	█	█	█	█	█					
Select best idea					█	█	█	█	█					
Draw idea with parts shown assembled						█	█	█	█	█				
Obtain materials							█	█	█	█				
Make parts								█	█	█	█			
Assemble design											█	█	█	
Use the patrol box														█

Lastly, estimate the cost of each idea and the financial resources available to you for your project. Engineers must always be aware of the cost of a project.

You have now established the beginning of a systems engineering operation. You have listed your operation’s resources (computer, calculator, tools, finances), and you have a means of keeping track of the progress of the scheduled steps of your project. Your systems engineering operation can apply to any project you wish to tackle and is limited only by your available resources.

2. Describe the Project Requirements

Clearly describe the project with a project statement. Your project description might be a statement of a relatively simple problem, such as: “Find the time required to fill a 100-gallon water tank with a constant flow rate of 10 gallons per minute into the tank, and with zero water loss or leakage.” However, a problem might be extremely complex mathematically, and still be solved with a clear, brief problem statement.

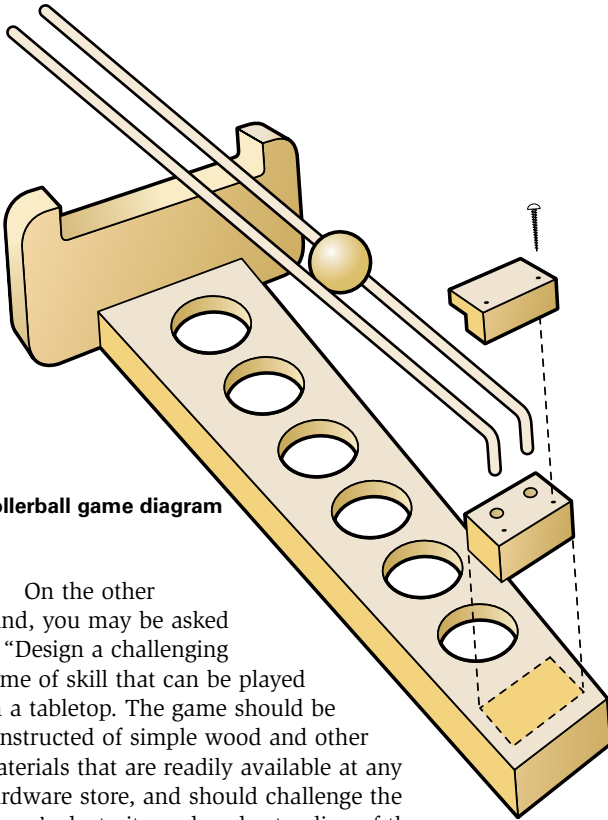

Rollerball game diagram

On the other hand, you may be asked to “Design a challenging game of skill that can be played on a tabletop. The game should be constructed of simple wood and other materials that are readily available at any hardware store, and should challenge the player’s dexterity and understanding of the laws of gravity and physics.” This is an example of the design class of problem. The solution is a project because a series of problems must be solved during planning and construction.

You are asked to devise a design solution for this project, which, in your judgment, best satisfies the design requirements. This type of project solution is called an *iterative* (or trial-and-error) solution and is typical of a design project, so you must carefully list all of the positive and negative requirements for the design. List the function (what it does), size, weight, materials, and any other factors that may come into play, such as the physical development of the person playing the game. For example, would your game be appropriate entertainment for a toddler?

For many projects, you may be required to consider environmental factors such as noise, air, or water pollution. Social forces in your community might also be factors, such as the need for ramps for citizens with disabilities.

3. Plan the Project's Activities, With Time Schedules

Compare the resources required to accomplish your project with your actual resources. You might need to look for more or different tools, or other pieces of equipment.

Let's assume that your project is to design a wooden rollerball skill game. The sample list of tools given in No. 1 are appropriate for many projects, such as designing a base camp patrol box, and will do just fine in this situation, as well.

Be sure to take inventory of the materials you will need, too. Because you are tackling a woodworking project, you also will need wood and wood screws, and you might consider adding a lacquer finish, paint, and paintbrushes to your list to put the finishing touches on your game. Sheets of fine sandpaper can be used to give your game a smooth finish. Felt pads for the underside of the game will help protect furniture from being damaged. And don't forget the steel rollerball!

You could choose to make a wooden skill game like this one, in which the challenge is to roll a steel ball along a pair of rods, dropping it into a cup with the highest point value. The rods have a slight uphill slope, and the player's objective is to manipulate the rods and ball to get the ball to roll up the slope. As the ball rolls over the cup with the desired score, the player spreads the rods quickly and the ball drops into the cup.

The trick to mastering the game is to spread the rods apart slowly to start the ball rolling, then work its momentum to roll the ball to the top for the highest possible score.



As indicated, you may purchase parts for your design project. Engineers normally buy many of the parts for their projects and perhaps need to make only a few of their own with the manufacturing tools available to them. As you design your project, you will decide which parts of your design to make and which ones to buy.

For our rollerball example, we bought the following parts:

- Long screws
- Steel rollerball
- PVC pipe end caps



We made the following parts from purchased lengths of plywood and wooden dowels cut to the proper length, as specified on your design drawings:

- The base and sides of the game
- Two half-inch wooden dowels



When designing the rollerball game, many engineering problems will need to be considered, like how far apart to place the cups and how high to place the rods. You also might discover different building materials that work better than the ones we used in this example.

Schedule your project steps on your milestone chart and leave room to describe your actual progress as you accomplish the project steps. If you have overestimated the complexity of a particular phase of your project, you will probably find that it takes less time to accomplish than you have scheduled. As an example, you may have scheduled three weeks for making design drawings or sketches. If it takes only four days, your actual progress will show a faster accomplishment of your project than your scheduled progress. This is why you should allow flexibility in your planning. If you take more time than you had planned, adjust the dates on the time scale. If you discover additional tasks (or steps) to be done, leave room on your milestone chart to add these new steps.



Review your planning at least weekly. Do not be discouraged if your planning requires several changes. This is a feature of the systems engineering approach. Assess your progress and feed information about necessary changes back into your planning system. You will learn a great deal from this and you will do better on your next project. Remember that leadership training in Scouting consistently stresses the importance of planning.

4. Conduct Research—Get Ideas

If your problem is analytical, you can review books and professional engineering journals to find solutions to similar problems. But if you have a design problem—a project—you must also look at similar design solutions (whether you are designing circuit boards, a sprint racer, or a dune buggy). Find out what other people have done. For the rollerball project, you would visit hobby or woodworking shops to see examples of other woodworkers' projects. The goal is to get the most ideas you can, even if you don't use them all.

You can also get ideas by brainstorming. Sit alone for a few minutes and try to clear your mind of outside distractions. Then list all design ideas that come to mind for the next 15 minutes. Look for ways to combine ideas to produce new ones. It doesn't matter if these are all good ideas. You will evaluate your ideas during the next step. Brainstorming with a couple of friends is more fun and can lead to more (and more creative) ideas. Write down all the ideas that are suggested. The wildest idea may eventually lead you to the best solution.



5. Develop the Best Ideas for Alternative Solutions

Now that you have lots of ideas, it is time to take a critical look at them, comparing one against the other. Decide which ideas will work best, which are the easiest to make, and which cost the least. Use your best judgment to narrow your ideas down to three.

6. Analyze the Best Ideas

Conduct a comparative analysis of your three best ideas.

- Sketch each idea, approximately to scale. The sketch should show all of the parts for the design.
- Study the sketch to ensure that the design can be assembled.
- List all the parts you will need.
- Carefully compare the three designs for ability to function, ease of assembly, ease of making the parts, and cost of the parts.

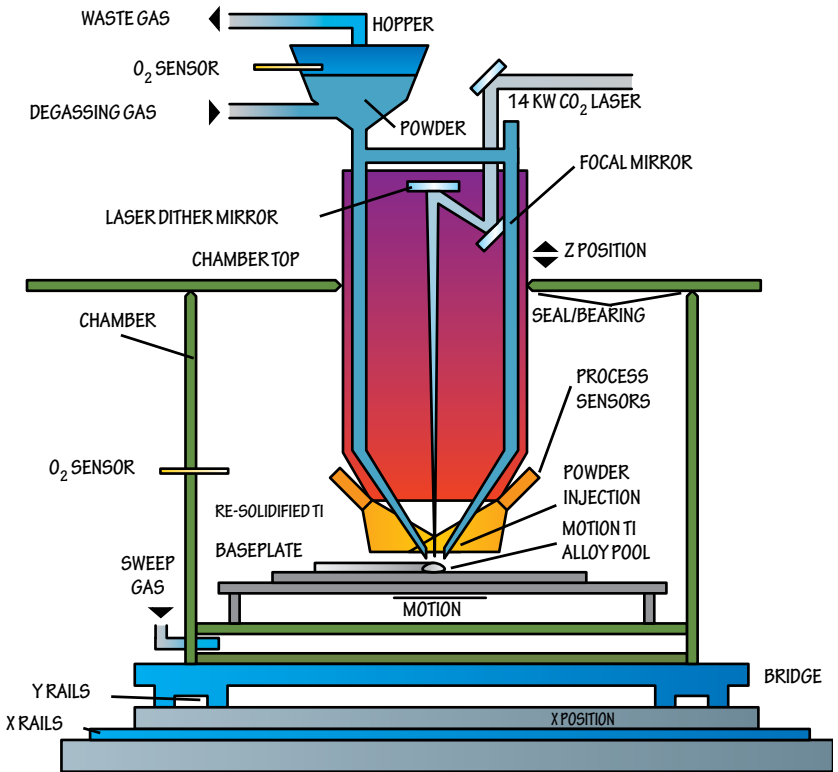

A technical illustration shows how a design functions. This is an example of how powder metallurgy transforms ground metal powder into strong and lightweight metal parts.

7. Select the Best Idea

Your analysis of the three alternative ideas will lead to the “best” idea. The best idea is the one that most closely matches the project requirements of No. 2. Briefly describe in writing why you selected this design as the best of the three alternatives.

8. Perform the Construction or Solution of the Project

For a design project, make your parts using the resources you identified when you established your systems engineering operation. Sketch the parts on paper, with dimensions. Buy the necessary materials, or use materials you already have on hand. Assemble the design.



9. Check the Solution

Verify that your design (problem solution) works as described in the project statement. Whether it is a wooden skill game, a patrol box, or something else, try it out. See how you like it—this is your creation.

As you have progressed through this process, you have established your systems engineering operation, made the appropriate entries on your milestone chart, and conducted a project. Congratulations! You have played the systems engineer’s role of documenting every step of the project and have made changes in planning, scheduling, and production, as required.



Basic Engineering Concepts

Understanding engineering takes some knowledge about the importance of measurements and a grasp of other basic concepts including velocity, acceleration, force (in action), power, and energy.

Measurements

An engineer must understand four basic types of measurements or quantities: length, time, mass, and force. All physical measurements can be related to these quantities or to a computation using them (called *derived measurements*).

Two common systems that measure these basic quantities are the English system and the metric system. In both systems, human beings, rather than nature, have determined the size of the basic units, such as the foot (English system) or the meter (metric system).

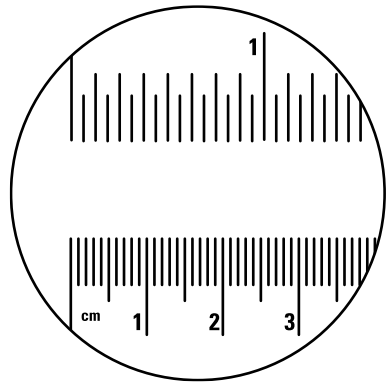

One inch on an English-system ruler equals approximately 2.5 centimeters or 25 millimeters on a metric ruler.

Metric scale



This scale is 10 centimeters long. It will take 10 of these scales to equal 1 meter. The marks between the numbers are millimeters. Ten millimeters equal 1 centimeter.

Length in Meters

1,000 meters = 1 kilometer — *kilo* means 1,000 units
 10 decimeters = 1 meter — *deci* means 10 parts of a unit
 100 centimeters = 1 meter — *centi* means 100 parts of a unit
 1,000 millimeters = 1 meter — *milli* means 1,000 parts of a unit

Weight in Grams

1 cubic centimeter of water = 1 gram
 1,000 cubic centimeters of water = 1 kilogram
 1 cubic millimeter of water = 1 milligram

Capacity in Liters

1 cubic decimeter of gas or liquid = 1 liter
 1,000 cubic decimeters of gas or liquid = 1 kiloliter
 1 cubic centimeter of gas or liquid = 1 milliliter



1 CM

← A CUBIC CENTIMETER LIKE THIS WILL HOLD 1 MILLILITER.
IF IT WERE FILLED WITH WATER IT WOULD WEIGH 1 GRAM.

↑ 10 CENTIMETERS = 1 DECIMETER



A CUBIC DECIMETER LIKE THIS WILL HOLD 1 LITER OF LIQUID OR GAS.
IF IT WERE FILLED WITH WATER IT WOULD WEIGH 1 KILOGRAM.

Abbreviations

- | | | | | |
|---------------|-------------|--------------|---------|---------------|
| CM—CENTIMETER | G—GRAM | KL—KILOLITER | L—LITER | ML—MILLILITER |
| DM—DECIMETER | KG—KILOGRAM | KM—KILOMETER | M—METER | MM—MILLIMETER |

This chart lists the units each system uses for each quantity. Research these systems of measurement on your own to learn more about them and other measurement systems. The units in boldface print are “basic” units that refer to a standard. The other units are derived from the basic units.

	SYSTEM	
<i>Measurement</i>	<i>English</i>	<i>Metric</i>
Length	foot (ft)	meter (m)
Time	second (s)	second (s)
Mass	Slug ($\text{lbf} \times \text{s}^2/\text{ft}$)	kilogram (kg)
Force	pound force (lbf)	Newton ($\text{kg} \times \text{m}/\text{s}^2$)

Basic units

In the English system, the basic units (boldface) are length, time, and force. Mass is derived from them. In the metric system, the basic units are length, time, and mass, with force being the derived unit.

In your daily life, you already use some of these quantities and the systems used to measure them.

Length is a measurement of distance. We can describe objects with three dimensions: width, height, and depth.

Time is simply a measurement of how long something takes to happen.

Mass is a measurement of the resistance of an object to a change in motion. In one sense, it is a measurement of how much “stuff” something consists of. Whether you are on Earth, floating in space, or standing on the moon, your mass is the same. While you are “weightless” in space, you still have your body and you are definitely not “massless.”

Force is an action that can cause a mass to change its motion. A mass (such as a car) will not change its velocity or direction of motion (whether at rest or moving) unless a force is acting on it. Forces will be discussed in more detail later.

Accuracy, Precision, Tolerance, and Validity

No measurement is perfect, and the exact or “true” measurement of a quantity can never be known. But we do use standards to represent the “true” measurement. The terms accuracy, precision, tolerance, and validity are often confused and used interchangeably. However, in engineering, these terms have exact meanings.



Accuracy is how good the measurement is compared to the actual or true value of the quantity being measured. Some devices are very accurate and some are not. A tape measure is much more accurate than an odometer in a car for measuring distance. A caliper is more accurate than a tape measure. A tape measure may be accurate to 0.001 meter, an odometer to 100 meters, and a caliper to 0.00001 meter.

Precision indicates the consistency of measurements. If four people each measure the width of a playing field, and each measurement differs by several inches, the measurements are more precise than if they had differed by several feet.

Tolerance is a range of acceptable sizes. If a fence post is to be made between 149 centimeters and 152 centimeters long, then the tolerance on its length is 3 centimeters. Engineers use tolerance to determine if parts will fit together after they are made. When you buy a replacement part for a bike, it will fit if it was made using the right tolerance.

Validity means that the measurement gives us the information we need to know. Invalid measurements can result from using the wrong measuring tool, measuring the wrong thing, or using the right tool incorrectly. What else could make a measurement invalid?

A measurement may be accurate and precise, but out of tolerance. Or, it may not tell us what we need to know and, therefore, might not be a valid measurement.

Other Basic Concepts

To do engineering, you need to know about a few more basic concepts.

Velocity. Velocity is an object’s speed in a particular direction. When you ride a bike in a straight line, we can measure your velocity. If you speed up, slow down, or change direction, you change velocity.

Acceleration. Acceleration is the rate of change in velocity. Technically, it refers to both speeding up and slowing down. To experience acceleration, try this. Sit in a car and close your eyes while someone drives. As the car begins to move faster (accelerates), feel your body pushing against the seat. When the car brakes (decelerates, a type of acceleration), feel your body trying to move forward out of the seat. When the car turns a corner, feel your body sliding toward the outside of the turn.

Acceleration, Force, and Mass

Recall that **force** can cause a **mass** to change its motion and that **acceleration** is a change in motion. Now, we can relate all three concepts.

Ride a bike on a smooth, level area such as a sidewalk. As you pedal, your rear tire pushes against the ground with some force. When you start out, you are changing the velocity of (accelerating) yourself and the bike (the mass) from zero to some speed. You can now coast without any additional force. But, you will eventually decelerate due to the friction forces in the bicycle mechanisms, in the wheels against the pavement, and in your body moving through the atmosphere (especially if you are cycling into a headwind).



Weight. *Weight* is the gravitational force exerted on an object. It differs from mass in that weight changes if gravity changes, while mass remains the same. For example, a bowling ball that weighs 12 pounds on Earth will weigh only 2 pounds on the surface of the moon, where the gravity is one-sixth as strong as Earth's gravity. And yet, the mass of the ball remains the same in both places.

Moment (or Torque). A *moment* is a force operating at a distance from a pivot point. When you open a door, you are exerting a moment about the door hinge, causing the door to rotate about that point.



Work. *Work* is done by a force acting on a body, so that the body moves in the direction of the force.

Power. *Power* is the time rate at which work is done. Pushing your bike slowly takes less power than pushing it fast. This is important, because much of engineering is about moving things or keeping things from moving (like keeping the roof from collapsing).



Newton's Three Laws

Scientist Isaac Newton (1643–1727) discovered three laws related to motion that will help you understand the concept of force.

1. An object (or “body”) in a state of rest or uniform motion will continue in its state forever unless a force acts on it to change that state. In other words, nothing is going to move or stop moving unless forced to do so.



2. If a force acts on a body, the body will accelerate in the direction of the force. The acceleration will be proportional to the magnitude of the force. That is, if the force is doubled, so is the acceleration.



3. To every force, there is an equal and opposite reaction. When you hit a baseball with a bat, both the ball and the bat experience the same force, but in opposite directions.



Energy

Energy is the ability to do work. It is classified in a number of ways. Let's look at common forms of energy and then consider how one form gets transferred into another.

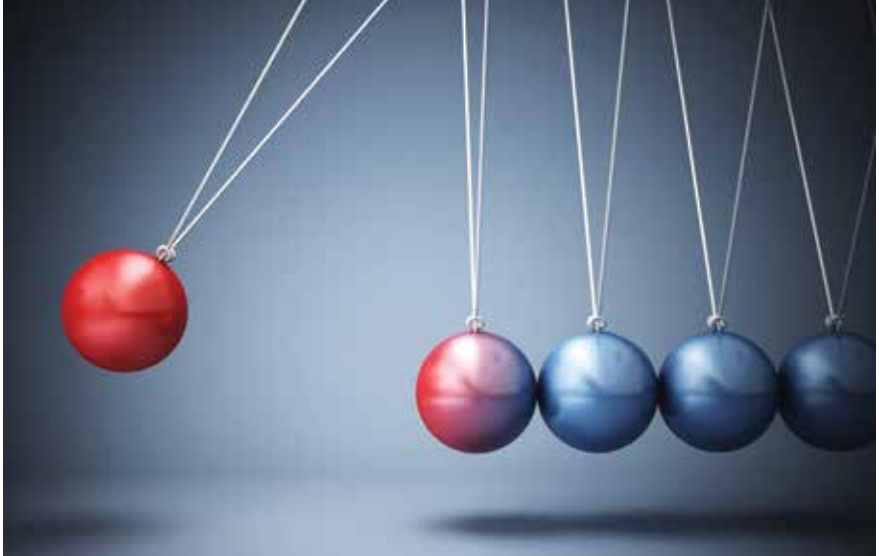

Kinetic Energy. Kinetic energy is the energy something has because it is moving. Drop a ball and see how high it bounces. Now throw it on the floor. The ball has enough energy to bounce higher the second time. Why? A moving object has more kinetic energy if it has more mass or is going faster. When you threw the ball, it was going faster than when you simply dropped it, so it had more kinetic energy.

Potential Energy. Potential energy is the energy something has while at rest after some energy has been put into it. Lift a book up to rest it on a chair. Push it off the chair. It will not reach a high speed before it hits the floor. Now, lift the book higher to rest it on a table; you have increased the book's stored energy. Push the book off the table. It will be going much faster when it hits the floor than when you pushed it off the chair. The book had more potential energy relative to the floor when it was on the table than when it was on the chair. The source of the potential energy is Earth's gravitational field.



Electrical Energy. Electrons flowing through a wire can transfer energy from one place to another. In homes, offices, and factories, it is converted into light (in lightbulbs), heat (in toasters, stoves, etc.), and mechanical energy (in motors, power tools, etc.). Electron flow is easiest to see in a lightbulb. As electrons flow through the filament of the bulb, the wire heats up and gives off light.

Electromagnetic Energy. Electromagnetic fields can best be demonstrated with a magnet. Hold a magnet close to a steel surface. You can feel the force of the attraction even though nothing is moving.

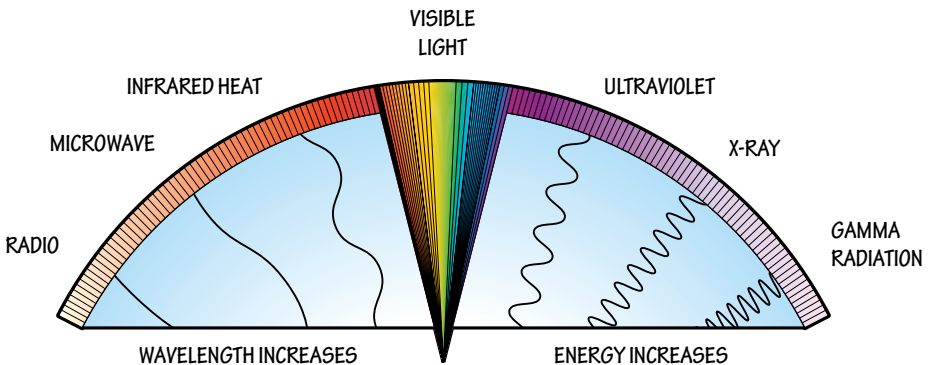

Electromagnetic radiation includes what we “see” as light. It is pure energy that moves in waves at a range of frequencies (the number of waves per second). If the frequency is fast enough, our eyes become sensitive to it, and we call it light. If it is slower, we can still feel it as heat. If it is even slower, we call it *radio waves* and use it for cellphone communications and Wi-Fi. If the frequency is faster than what we see as light, it moves into the categories of ultraviolet, X-rays, gamma rays, and cosmic rays, which are measured along a continuous spectrum. The energy is related to the frequency.

Chemical energy includes the energy stored in batteries.

Chemical Energy. Matter is made of atoms and molecules (combinations of atoms). The atoms bind together in various ways to form solids, liquids, and gases. That binding is a form of stored energy. When these bonds are broken, energy may be released or absorbed, depending on the material.

There are all kinds of examples of chemical energy around us every day. When gasoline is joined with the oxygen in the air, chemical energy is released in our automobile engine to make it run. The chemical energy of wood burning in a fireplace

releases heat and keeps us warm. The chemical energy in dynamite is released to clear construction sites for new buildings and roads.

Nuclear Energy. Individual atoms are made up of electrons surrounding a nucleus of protons and neutrons. The type of atom is determined by the makeup of the nucleus, which has a binding energy keeping it together. Splitting a “heavy” atom (fission) releases enormous amounts of energy—the energy source for nuclear power plants and nuclear bombs. Combining

two “light” atoms (fusion) can produce even more energy. To this day, no one has been able to make a working power plant based on fusion.

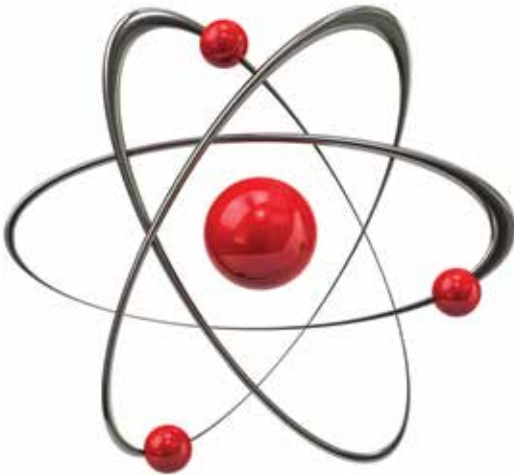

Thermal Energy. Thermal energy is best demonstrated by an example. Put water in three bowls—hot water in the first bowl (not too hot for your hand), warm water in the second bowl, and cold water in the third. Put one hand in the hot water and your other hand in the cold water. After a few minutes, put both hands in the warm water. Does the “cold” hand feel warm and the “hot” hand feel cool?

The flow of thermal energy from one place to another is called *heat*. In this case, heat is being transferred between your hands and the water. Heat will flow from the hot hand to the water, and from the water to the cold hand. Both hands and the water will eventually reach the same temperature (thermal equilibrium—the temperature is balanced).

Remember the lightbulb? The flow of electrical energy causes the wire to heat up (thermal). The thermal energy is then converted to electromagnetic radiation (light).

Energy Conversion

Engineers make use of energy by converting it—from stored to transitional, from one transitional state to another, or from one classification to another.

Some air conditioners make use of latent heat. Warm air is forced through a stream of water or through wet filter pads, causing some of the water to evaporate (changing the state of the water, or latent heat transfer). The evaporation process takes energy from the air, cooling the air. This type of air conditioner is called an evaporative cooler.

Other increasingly popular methods of energy conversion use solar energy. The heat of the sun can be used to heat a fluid, and that heated fluid can be used to drive a turbine. Solar energy can also be used to create electricity directly, in solar cells.





Let's Do Engineering

In this chapter you will find ideas for ways to fulfill requirement 6, whether you are interested in transforming motion, using electricity, using materials, converting energy, or moving people. There is also information about competing in a science or engineering fair.

Transforming Motion

Engineers, particularly mechanical engineers, are often interested in things that move to make life or work easier. That includes all forms of transportation (bicycles, cars, trains, planes, etc.), machinery, tools, satellites, computers, and many other things.

There are two forms of movement: straight-line and curved. Making one thing move by moving something else is called *transforming motion*. The curved motion of bicycle wheels going around (rotating) transforms the motion of the bicycle to straight-line (linear) motion. Engine pistons moving back and forth in a straight-line motion make a crankshaft go around in a curved motion.

Two basic ways to transform motion are the inclined plane and the lever. You may not know it, but these are simple devices you use every day. Even machines that look highly complex mostly use variations on these two simple ideas.

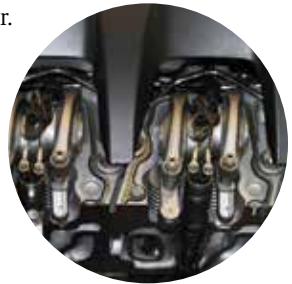

A screw is an example of an inclined plane wrapped around a shaft. Some automobile jacks use a type of screw to lift a car. Can you think of other examples of inclined planes?

Inclined Plane

An inclined plane is simply a sloping surface. Try to lift a heavy object onto a platform or table. Next, place a board sloping from the table to the floor and slide the object up the board. Which was easier? Why?

Lever

A lever is something such as a metal bar or plank of wood pivoted about a *fulcrum* (a prop or support). A seesaw is a good example of a lever in action. Have you ever tried to balance a seesaw with you on one side and someone else on the other? The *moment* (see “Basic Engineering Concepts”) of each person on the seesaw is the person’s weight times the person’s distance from the fulcrum. For the seesaw to balance, the movements must be equal and act in opposite directions—the lighter person must move farther from the fulcrum.

The lighter person can “lift” the heavier person with just his own weight by moving farther from the fulcrum. Also notice that the weight of both people is down, resulting in movements in opposite directions. Try using a lever to lift or move an object that you normally could not lift or move.

Your arms and legs also act as levers. Your upper arm rotates about your shoulder and your lower arm rotates about your elbow with muscles doing the work. Hold an object in your hand with just your elbow resting on a table. Then extend your arm. Notice how much harder it is to hold the object with your arm extended. What other levers does your body have? What other examples of levers can you find?

Linkages

Linkages use two or more rods or bars to transmit motion. Try doing a push-up. There are four links in this motion—your body, upper arms, lower arms, and the floor. The rotational motion at your toes, shoulders, and elbows allows for the body motion.

Examine the interaction between you and a bicycle while riding it. Your upper and lower leg pushing on the pedal are two links. The pedal and the gears are another link. Your body and the bike frame are a fourth link. The principle of linkage creates linear motion from a series of rotating motions.



Examine a few common devices that use linkages—an umbrella, folding table legs, a bicycle gear shift. How many links are there? How do the linkages provide the appropriate motion? How is the motion restricted?



Pulleys

Pulleys also use the leverage principle. In this case, the lever is a circular disk and the forces are applied using a rope or cable. Pulleys may include one or more disks of varying diameters to produce the desired effect. Look for examples in and around your home, such as a curtain draw, an automobile fan belt, or a sewing machine.

Gears

Think of gears as pulleys with teeth. Gears may be circular, cylindrical, flat, or other shapes. All gears have teeth that can mesh with other gears, and frequently with a chain. You can view gears as a series of interacting levers. Take a close look at a bicycle. It will include two or more gears connected by a chain that grabs the teeth to transmit the force from one gear to the other. Where else can you find gears? How do they interact?



If you choose to do requirement 6(a), discuss with your counselor a mechanical problem you can solve using the principles of transforming motion. Here is an example problem: Using materials you find around home or at a local store, build a device that will transport a 10 kilogram (minimum) object up a slope at least 2 meters long and 1 meter high, and then stop. It should not use any human power during the operation. Describe to your counselor how you decided on your solution, how it might be improved, and at least one other way it might be done.

Using Electricity

If you choose to do requirement 6(b), you can get a taste of what electrical engineering is like by learning how electricity is used in your home. You will find out how much electricity your family uses and how much it costs. This might also lead you to consider how you might conserve electricity, to save money and to help the world.

What things in your home are powered by electricity? List at least 10 examples. To find out how much electricity each uses, look for the nameplate on each. It will look something like the one shown here.

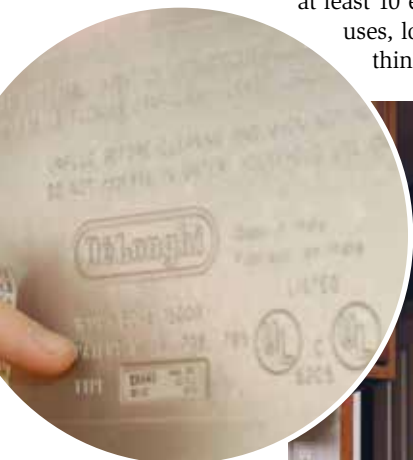

Volts refers to the required operating voltage. *Cycles* is usually 60 hertz for North America. *Phase* is usually 1, for “single phase,” but may be 3 for three-phase power appliances. *Amps* is the operating current. *Watts* is the power consumption. (Watts = voltage x amperes.) (For more about these terms, see the *Electricity* merit badge pamphlet.)

Some appliances, such as refrigerators, air conditioners, water heaters, or furnaces, may also have a label that tells you how much electricity the appliance typically will use in a year. It will usually be in *kilowatt-hours* (kwh). If the appliance in the example used in the chart were always on for an entire year, it would use 100 watts x 24 hours a day x 365 days a year ÷ 1,000 watts per kilowatt = 876 kwh/year.

For this study, the figure you are interested in is watts, the measure of power consumption. Every day for a month, keep a record of how long a particular appliance is used. Some of your figures will have to be estimates to the nearest half-hour or 15 minutes. Make your estimates as accurate as you can.

At the end of the month, you can make a record in a chart like the one shown here. Perhaps you will find, in keeping your record, that some of the appliances seem to use a lot of power. Ask yourself why. Watch the appliance in use.

Appliance	Watts rating	Hours used per month	Kilowatt-hours (Watts rating X hours ÷ by 1,000)	Cost
Toaster				\$
Iron				
Refrigerator				
Humidifier				
Dehumidifier				
Furnace				
Air conditioner(s)				
Clothes dryer				
Washing machine				
Dishwasher				
Television(s)				
Lights				
Living room				
Bathroom(s)				
Total				\$

Cost per month equals the total kilowatt-hours times the cost per kilowatt-hour. Ask your parent or guardian to let you look at your home's latest electric bill to find the cost per kilowatt-hour. Or, you can find this out by calling your local electric utility company.

What ways can your family conserve electricity? Some methods might just call for breaking poor habits; others take a more active approach (with your parent or guardian's permission).

- Turn off the lights when no one is in the room.
- Turn off the TV when no one is watching it.
- Before you run the dishwasher, make sure it is full.
- Don't linger in front of the refrigerator door when you are looking for a snack.
- Use ceiling fans to help circulate the air. (Remember to reverse the direction of the fan blades in wintertime.)
- Use a 7-watt nightlight in the bathroom at night instead of a 60-watt regular bulb.
- Use LED bulbs in lamps instead of regular incandescent bulbs.

Think of more ways your family could conserve electricity. Talk them over with your merit badge counselor. If you are interested in other electrical engineering problems, consider earning the Electricity, Electronics, Energy, and Computers merit badges.

Contact your local power company and ask how much electricity you could save if you raised the temperature of your air conditioner by 1 degree in the summer, or if



you lowered the thermostat for your home-heating system by 1 degree during the winter. Find out how much electricity is saved, on average, when homeowners switch to a programmable thermostat, which automatically adjusts the temperature setting for different times of the day, such as when family members are not home or are sleeping at night. Afterward, share this information with your parent or guardian. Discuss how

these small changes can result in big savings—both energy and money—for your family.

Using Materials

Engineers design and build things out of many different materials. Different materials behave differently when put under a load. There are several important concepts: stress, strain, stiffness, and strength. If you choose requirement 6(d), you will do experiments that demonstrate these ideas.

Stress is the load placed on the material by area. If the load is spread over a large area, the stress is small. If concentrated on a small area, it is high. Push the blunt end of a pen or pencil against your skin. Now push with the same force using the pointed end. The cross section of the blunt end is much greater than the pointed end. You can definitely feel the higher stress with the point.

Strain is how much the material changes when under stress. Stretch a rubber band. As you pull it, you are putting a load on the material and stressing it. That results in a strain, or change in length. All materials change dimension under load, even the hardest steel. However, special instruments are needed to measure the strain.

Stiffness combines stress and strain to describe how a material changes over a range of loads. It tells us how rigid or flexible something is. A steel bar is rigid. Licorice is flexible. Does the material behave the same way in all directions? How about a steel wire? It is rigid when you pull it, but flexible when you bend it. Why?

Strength is the stress at which the material breaks (ultimate strength). Engineers also consider the stress at which a material deforms and stays deformed (yield strength). When you blow up a balloon a little, it will come back to its original shape. If you blow it up all the way and let the air out, it will “yield” and not come back to quite the same shape when you let the air out. Keep blowing and it will reach its ultimate strength—but watch out! The material strength is often confused with structural strength. The strength of a structure is the load at which it will break, not the stress. We will look at that later.

Describe different parts of your body in terms of strength and stiffness. Also, look at various plants and trees. How do they use stiffness and strength to function?

In the book *The New Science of Strong Materials*, author J. E. Gordon puts it this way: “A biscuit is stiff but weak, steel is stiff and strong, nylon is flexible and strong, raspberry jelly is flexible and weak.”

Let's take some measurements to tie the concepts together. Hang a rubber band from a hook or paper clip. Hang a paper cup from the rubber band using another paper clip and string. Measure the length of the rubber band. Add weights to the cup in even amounts (for example, marbles, fishing weights, or pennies). As you add each weight, measure the new length of the rubber band. Take at least four measurements and plot them on a graph. That will be the stress/strain curve. What factors, such as the thickness of the rubber band, might skew your results?

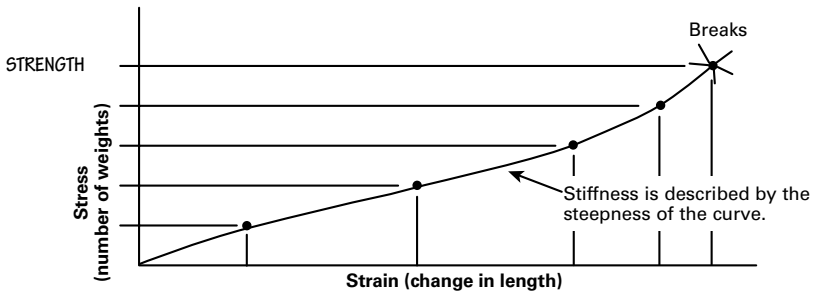

The stiffness determines how steep the curve is. For a rubber band, the slope of the curve will change. If you were to use steel or aluminum in the same experiment, the curve would be very steep and straight until it reached the yield strength. The slope of the curve describes the stiffness of the material. If the curve is shallow, the material is flexible (rubber band). If the slope is steep, it is stiff. For brittle materials such as glass, the stiffness is the same for the entire curve. For materials such as steel and aluminum, the curve is straight until the material permanently bends.

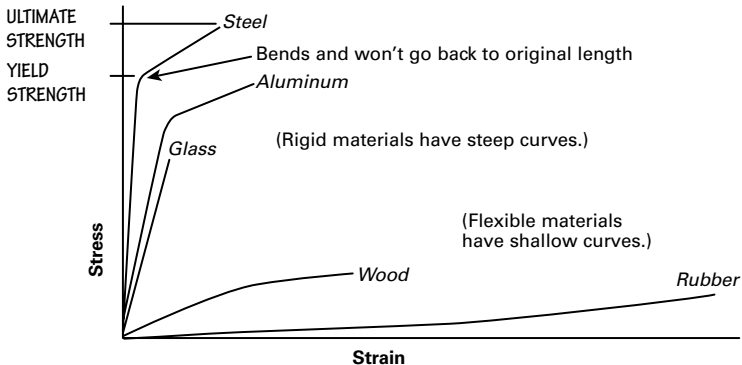

Try bending pieces of different materials such as steel, aluminum, wood, and plastic with your hand. How do you think their stress/strain curves would look?

Now let's take a look at structural strength (as opposed to material strength). Take a sheet of paper and try to stand it on its edge without bending it. The sheet won't support its own weight, let alone something else. Paper is not very strong or stiff. Now roll the paper so it forms a tube and tape it together. Stand the tube on its end and see how much weight (for example, how many DVDs) it will support. Engineers combine the material properties with structural shapes to make very efficient structures. What types of shapes do you see in skyscrapers and machines? How about in nature?

Reaching for the Skies

The first steel-framed building called a skyscraper was designed by William Le Baron Jenney (1832–1907). Built in Chicago in the late 1800s, the Home Insurance Building was initially nine stories high. By 1910, New York had its first 50-story building, and by the 1930s, the Empire State Building claimed an unprecedented 102 stories. What makes skyscrapers so amazing is how engineers must design their structures to withstand the elements, like gravity and wind.

Examine some items you have around your home such as fingernail clippers, vise grips, clocks, tape measures, and so on. Think about how the different materials are used and why.

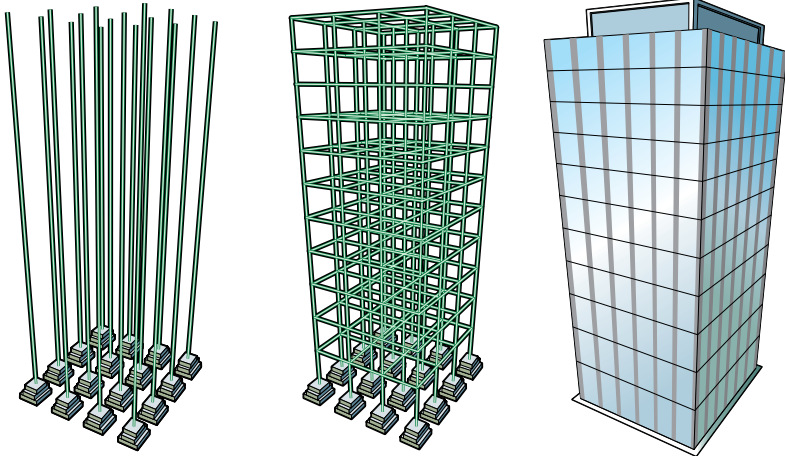

Heat and Materials. How materials behave with temperature is extremely important. Different materials conduct heat differently. Changes in the temperature of a material can also change its dimensions.

Temperature can affect a material's stiffness. Put a rubber band in the freezer for 30 minutes. Does it behave the same as it did at room temperature?

In space, the temperatures on parts of a satellite can change 100 degrees or more over a short time as the satellite moves in and out of the sunlight.

Experiment: Heat Transfer

Bring a pot of water to a boil. Drop a metal tablespoon, a piece of wood, and a piece of plastic into the boiling water. After a minute, use tongs to remove the pieces from the water, one by one. Touch each one lightly with your fingers, taking care not to burn yourself.

What are your conclusions about the heat conductivity of metal, wood, and plastic? If you wanted to insulate something, which material would be best? If you wanted to transfer heat quickly, which material would you choose? Discuss your conclusions with your counselor.

Materials can also change dimension with temperature. Most will contract (shrink) when cold and expand when hot. Some do just the opposite, and some change very little.

Experiment: Changing Dimension

Glue a strip of aluminum foil to a piece of paper the same size (a glue stick will work fine). Make sure the combined strip is flat; put it in a freezer for 15 minutes. What happens to the strip? Now carefully take it out and let it reach room temperature. What happens to the strip? What is happening to the aluminum and paper combination to cause the strip to change shape?

Sometimes you can hear a house creak at night when there is a big change in temperature. Also, doors in your house may close easier in one season than in another. The materials are expanding and/or contracting because of temperature. Engineers have to be very careful when connecting different materials.

Electrical Properties. Just as materials respond differently to heat and cold, so do they respond differently to electricity. Materials that carry electricity are called *conductors*. Materials that resist carrying electricity are called *insulators*. Copper, used extensively in electrical circuits and wiring, is a good conductor. Rubber, used to encase the copper in electrical wiring, is a good insulator. Can you think of another example of an insulator and where it is used? What about a conductor and its use?

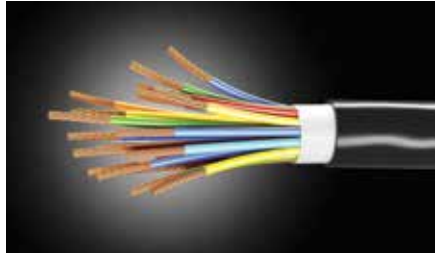
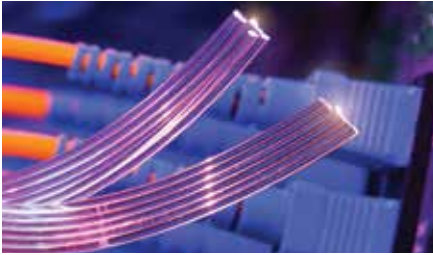

Optical Properties. Why do we use glass instead of plywood for windowpanes in a house or for windows in an automobile? The question is not as silly as it seems. The answer lies in the *optical properties* of the material. Why do doctors and nurses use lead-lined aprons when they take an X-ray, rather than standing behind a plywood door? Because the optical properties of a material must be matched with the type of radiation it will encounter. Visible light, such as passes through a windowpane, is only one type of radiation. X-rays are a completely different type. You can't see them, but they are there.

Radiation and Absorption. One of the most fascinating properties of a material is its ability to *radiate* or *absorb* energy in the form of waves. The sun is the most prominent radiator of energy. If you stand in the sun, it feels a lot hotter than if you stand in the shade because your body absorbs the heat from the sun's radiation. Wearing white clothing feels cooler than wearing black clothing in the sun, because the black material absorbs more of the sun's heat-energy waves than the white material does.



Similarly, using different types of waves, we turn on a TV set with a remote control. The remote control radiates invisible light waves that are picked up, or absorbed, by a device in the TV set. If you point the remote control at yourself, you don't feel anything. If you look at it, you don't see anything coming out when you push the button. Try using your remote control on your neighbor's or friend's TV. It may not work. That is because your TV and someone else's use slightly different waves.



Chemical Properties. When engineers study how a material interacts with other materials and external stimuli (stimulants), they are studying the material's chemical properties. Fire-resistant construction requires materials that do not burn easily. The liquids and solids in batteries are chosen because of their *chemical properties*. What kinds of chemical properties would you want in your materials if you were designing a match to light a fire?

Another important chemical property is *resistance to corrosion*. Materials can react with oxygen, water, salt, or just about any substance. What is important is the rate of reaction and how long the material must survive. A bridge over salt water may be expected to last 100 years, but a resealable plastic bag might be expected to last for only a year. How long would you expect the steel body of an automobile to last in Miami, Chicago, or Phoenix? Why might you expect any differences? (Hint: Consider temperature, humidity, salt air, and the road salt used to melt snow.)

Properties of Liquids. Liquids are sensitive to temperature and have a freezing point and a boiling point. Water turns to ice (a solid) when the temperature goes below 32 degrees Fahrenheit and becomes steam (a gas) when the temperature goes above 212 degrees Fahrenheit. Liquids can also evaporate (turn to gas), just by sitting long enough. Another important property of liquids is their resistance to motion, which is called *viscosity*. You can swim in water, but why would it be difficult to swim in a pool of honey? Because honey has a high viscosity.



Think of some liquids that you encounter in your daily activities and identify the ones with high or low viscosity.

Classifications of Materials

We have discussed the characteristics of materials that an engineer must consider. Now let's look at other considerations, including the type of material and the manufacturing method.

Materials are classified into metals, composites, ceramics, polymers, electronic materials, and other groups. For each class of materials, the method of manufacturing is important. Questions about how a material can be made into a given shape must be addressed. Engineers also must know how to predict the behavior of a material all the way from raw material to finished product. To do this, the engineer develops equations and computer programs to describe the material and its characteristics.

Imagine you are an engineer with a company that makes all sorts of different products. The chief engineer has given you and the other engineers the task of developing new and superior versions of those products. Specifically, you want to improve the following.

- **Fishing rods:** In the past, they have been made from materials including bamboo, steel, and composites. What material might make a better rod?
- **Bicycles:** What might you look for in a material to build a better bike?
- **Shoes and sneakers:** What properties of a material would allow you to make a better sole and heel on a shoe?
- **Automobile bodies:** What properties of a material are important for building a better car body?



Structures

Structures are the most common “engineered” devices around. They include all buildings, chairs, tables, signposts, bridges, dams, frameworks for automobiles, airplanes, satellites, etc.

A structure’s capability depends upon the materials used, the shape of the materials, their position (or *orientation*), and how they are interconnected.

The primary responsibility of a structure is to transmit loads. When the wind blows, the rain falls, the earth quakes, or someone is on the roof, you don’t want your home to collapse.

Review the example demonstrating paper’s structural strength from page 71. Using materials such as straws, toothpicks, string, glue, etc., build a bridge across a 1-meter span. Add weights (pennies, paper clips) to the middle and observe the deflections (in this case, the curvature) the weights cause. How could you strengthen the bridge? How might you make it simpler or lighter and keep the same strength? How is the load of the added weight transmitted by the different parts to the ends? Which are in tension? Which are in compression?

An engineer must consider a structure’s strength, stiffness, weight, and cost. These elements often conflict with one another. Reducing the weight and/or cost may affect the strength and stiffness. Sometimes the structure needs to be able to *flex* (be less stiff), but still be strong and light. Consider a bicycle wheel. The wheel needs to be strong enough to support your weight and handle the bumps it encounters. However, it also needs to “give” to provide a comfortable ride and it needs to be lightweight for ease of handling.

All materials, such as paper, have some amount of strength that will allow them to carry a load before failing. All shapes have properties that allow them to carry loads. The ways in which structural elements fit together also have properties to carry loads. The engineer’s task is to find an appropriate combination of material, shape, and interconnection for a particular task.



Shapes

One common solution for increasing strength and stiffness, while reducing weight and cost, is designing with the simple triangle. Take four boards of equal length and join them. Use one nail at each corner to form a square, but keep the joints a little loose. How stable is it? Does it want to collapse? Can you twist it?

Now take out one of the boards and join the three remaining boards. Is this structure stable? Does it collapse or twist as easily? The square is not stable because there are an infinite number of positions (solutions) a four-sided square can assume between a square and the collapsed position. However, there is only one solution to any given three-sided shape (triangle).

Go back to the four-sided square and add a fifth board from one of the corners to the opposite corner. Does this improve the stability? Does it twist as easily? Why? Look at a bicycle again. How is it framed to make it strong and stiff, but lightweight? Can you find examples of triangles used in other structures?



Another thing to consider is the cross section of a structural member. The most common shapes for structural members include circles, squares, rectangles, L's, and I's. The I beam is often used because it is stiff in the direction that is needed but is relatively lightweight and inexpensive—it makes efficient use of materials. Take a look at a board with a rectangular cross section, such as a two-by-four. Does it bend as easily in both directions? Look at the boards used to support the roof of a house. How are the boards oriented? What would happen if the boards were turned 90 degrees?

Take a look at natural things such as trees, plants, animals, and hills. How are they structured? What loads must they carry? How do these structures “behave”?

Out on a Limb

If having a hideout of your own sounds appealing, a treehouse can fit that bill perfectly. Before you get started, you should know that building a treehouse takes a lot more than a hammer and a few nails. Yep, constructing a structurally sound treehouse is tricky business.



For added convenience, check out ready-made plans that give step-by-step instructions to build a structurally sound treehouse. Be sure you have your parent or guardian's permission before you attempt to plan a treehouse.

Not All Trees Are Created Equal. You will need to find out whether the tree you have in mind can endure the stress and alterations that may be in store. A certified arborist, or tree expert, can examine the tree's health and condition from the roots to the tip-tops. The inspection will reveal whether the tree can support the weight of the house you want to build.

It's All About the Tree. The tree's structure will help determine the height and size of the treehouse. Find a spot that is not so high that your structure will twist along with the tree's movement in the wind—10 feet up usually is about right. The arborist may be able to provide some direction here and can also tell you how to care for the tree once the structure is in place.

Planning Your Retreat. This is where the systems engineering approach to problem solving comes into play. Start by making a list of your available tools and materials and those that need to be obtained. Keep in mind that a project of this scope takes a lot of resources—including money.

Look for ideas to incorporate in your treehouse. When you are ready to sketch your dream house, make sure to adapt the design to the structure of the tree. Once your sketch is refined to a workable plan, start gathering the materials you will need to build and go for it!

You can see that building a fort in the sky is not something that can be done on impulse. Making a treehouse takes careful planning from start to finish. Yet a project like this presents an excellent opportunity for you to explore how engineering touches our lives day-to-day.

For more details about designing and building a treehouse retreat, get your parent or guardian's permission to visit The Treehouse Guide at thetreehouseguide.com. This site is just one of many helpful online resources.

The screenshot shows the homepage of 'The Treehouse Guide'. At the top, there are navigation links for 'Home', 'Treehouse plans', 'Treehouse Guides', and 'Contact Us'. Below the navigation, the main content area is titled 'Treehouse plans' and includes the text: 'Practical design information to help you build your own treehouse, safely and with the absolute best results.' It also says 'Have a look through the [guides](#) which pages in addition to any plan you may use.' and provides the URL www.thetreehouseinfo.com. There is a central image of a treehouse under construction. To the right of the image, there is a section titled 'For a complete approach to building a treehouse, visit our sister site [Treehouse Guides](#).' Below this, it says 'Professional step-by-step designs tell you everything you need to know to build a safe treehouse. Cutting lists and dozens of colour diagrams make the process straightforward. Plans are purchased online and are then available for immediate download so you can start today. If you know someone who is always hard to find gifts for, this is sure to be original.' At the bottom, there is a section titled 'Simple plan' with the text: 'A series of simple treehouses show you how you should think about setting about the design and build process of your own house. The treehouse is not meant to be beautiful, more a demonstration of how'.

Converting Energy

Many of the machines that make our lives comfortable depend on the conversion of energy from one form to another. How does a car move? Oil (chemical energy) is pumped (mechanical energy) from the ground. It is then processed (by heat, chemical, mechanical, and electrical energy) into gasoline (chemical energy). The car then converts the gasoline to mechanical and heat energy by using mechanical, heat, and electric energy.

Examples of such energy conversions are all around. Your body is an excellent example. You eat food (stored chemical energy) and convert it to heat, plus other forms of chemical energy stored in your muscles. Your muscles convert chemical energy to mechanical energy to move your legs to ride a bike. Your body also converts chemical energy to electrical energy in the neurons and synapses of your brain when you are thinking about how to ride the bike. When you sweat while riding, thermal energy is releasing heat, allowing your body to cool.

A common example of energy conversion that you could research is how a car or flashlight battery converts chemical energy into electrical energy. Check at your school or public library for books on electricity. Look in the indexes under "battery." (If you use the internet, be sure you have your parent or guardian's permission first.) Study the explanations and be prepared to tell your merit badge counselor what happens when a car battery is used or a flashlight is turned on.

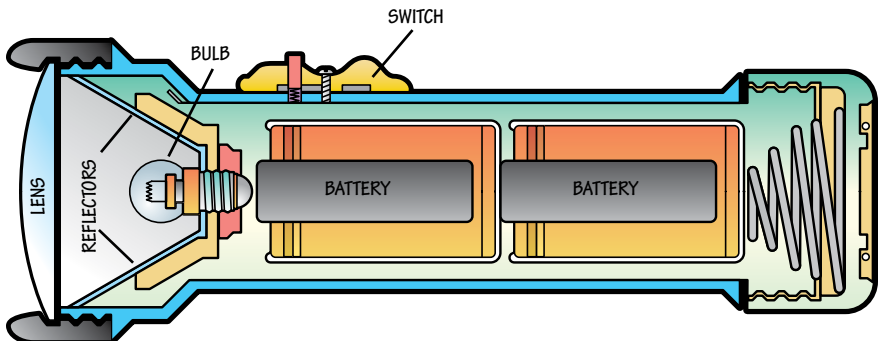

A flashlight converts chemical energy from its batteries into electrical energy.

Solar Energy

Solar energy is virtually unlimited, and the sun's rays fall everywhere on the face of the Earth. But solar energy has one serious disadvantage: You can't turn it on or off. At night and on cloudy days, there is little solar energy to catch. This means that for heating a house, you need another source of energy part of the time.

Some homes have simple solar energy systems for heating. The sun's heat is collected by flat-plate collectors and heats the circulating water. The hot water goes to a storage tank and then passes through the house's heating system. As the water cools, it is pumped back to the collectors where the sun reheats it.

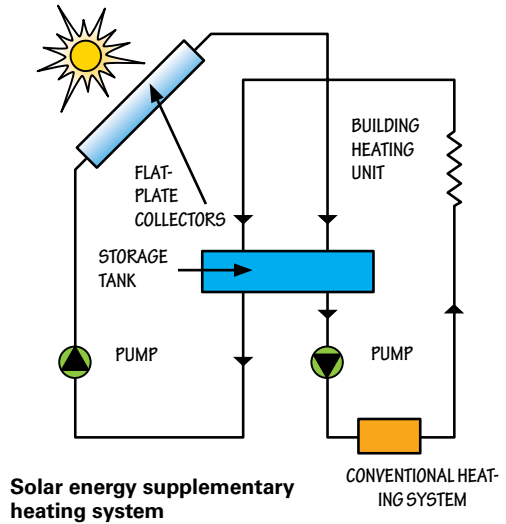

Solar energy supplementary heating system

Experiment: Solar Energy

Try this experiment on a sunny day.

- Step 1**—Fill a cake pan or pie tin with water.
- Step 2**—Measure the water's temperature.
- Step 3**—Place the pan in the sun.
- Step 4**—Measure the water temperature every two hours for six hours.
- Step 5**—Measure the water temperature at sundown and again at sunup the next morning.
- Step 6**—Repeat step 4 on a cloudy day.

What do your findings tell you about the value and potential of solar energy? Why does a house heated by solar energy need another energy source for continuous heating?

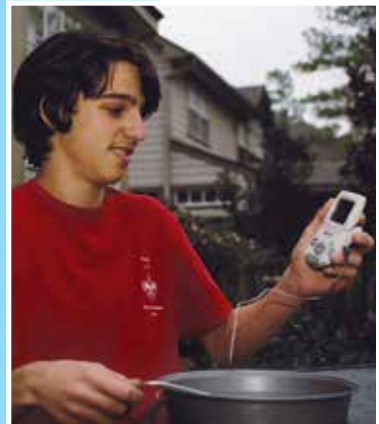

Moving People

Americans are always on the go. Most people have to travel to work or to school, to shop, and to their place of worship. Because we travel so much, and most of what we buy must travel from manufacturers to stores, we depend heavily on transportation systems. These systems include roadways, railways, bus lines, trucking companies, airlines, pipelines, and waterways.



Engineers are called upon to plan, design, and manage these systems. Engineers who work for your city or region probably have studied the existing transportation systems. Their aim is to find ways to improve or expand the systems to make travel easier, faster, safer, and cheaper. You can find out about their plans in the office of your city, town, or village engineer. Your merit badge counselor will also help you.

Making a Traffic Study

If you decide to do requirement 6(f), you can find some of the data you will need from the city, town, or village engineer. The engineer can tell you about predictions for population and number of cars in five years or more. Your merit badge counselor may be able to suggest where to make your traffic study.

Visit the location at least once during both its heavy and light traffic periods. Two or three visits on different days of the week would be even better. You will get a more accurate count of the average number of cars, trucks, and other vehicles using that roadway.



If you find that population and number of vehicles are expected to increase over the next five years, be prepared to suggest ways to handle the heavier traffic. Talk with your counselor. Your solution will depend on the particular location. You might recommend widening or straightening the road. Or, the answer might be to build a thoroughfare or tunnel, install a traffic light or turn lane, make the street one-way, or implement some other idea for improving the traffic flow. Some communities have installed roundabouts, which are common in Europe. Research the pros and cons of roundabouts.

Share your data and your proposed solutions with your counselor.

Creating a Science Fair Project

Science fairs and engineering-team competitions are sponsored by a variety of organizations. Many schools, colleges, universities, and professional engineering societies sponsor engineering fairs and competitions every year.

How to Pick a Project or Competition

There are many ways to pick a project or competition and also meet requirement 6(g). Remember that the project or competition that you choose should be related to examining an engineering question, rather than gathering pure scientific research. For ideas, just look at the world around you or at recent news events. Consider how scientific principles may have influenced them. Look at your personal interests (sports, bicycling, or skateboarding, for example). How might they be improved upon or studied?



For another example: How can the effects of low rainfall be minimized? Think of ways to prevent or reduce the effects of a drought. What water conservation efforts work in your community, and how can they be improved? Asking some of these questions, and performing experiments to find possible answers, can form the basis of a good science fair project.

As you consider the different types of subjects and projects that interest you, begin to research and assemble information in your area of interest. Your research tools should include the World Wide Web, libraries, and related industries.

Ask your science teacher and merit badge counselor for guidance. Planning, developing, organizing, and building your entry into a project that will meet the particular requirements of a fair or competition can be complicated. Some competitions may require both a scientific investigation and a demonstration concerning the subject you have chosen (such as designing the most structurally sound miniature-bridge design using specified materials, and then building the miniature bridge).

Remember that another way to meet the requirement is to become a member of an engineering-project team. Project teams enter local competitions, and often the winners can go to national competitions.

The Joy of Engineering

For any given engineering problem, there are many solutions. It would be great if we could always find the “best” solution. Engineers, however, must work within limitations imposed on them by available materials, supplies, money, and tools. They must be sensitive to environmental concerns, politics, and the culture of their company and the community. There is tremendous satisfaction in solving a problem when faced with such challenging constraints.

Learning From Our Mistakes

It has been said that engineering advances one failure at a time. With every failure comes the chance to learn how to improve design and technique. The engineer seeks the proper balance of quality of construction and acceptable cost, while not compromising function or safety. A constant danger is becoming overconfident, believing that failure can't happen. Here are some examples of famous engineering mistakes that also led to engineering improvements.

The *Titanic*. The RMS *Titanic* was the largest passenger ship in the world when it sank on its maiden voyage from England to the United States in 1912. Shipbuilders had dubbed the ship “unsinkable.” The ship was built with 16 compartments and could stay afloat even if up to four of them were flooded. A fatal design flaw, however, was that the compartments were not sealed at the top. When the ship brushed a giant iceberg, water rushed into forward compartments, spilling over the top of the bulkheads into adjacent compartments, sinking the ship and costing 1,523 people their lives.

Tacoma Narrows Bridge.

This two-lane, mile-long bridge over Washington state's Puget Sound collapsed four months after it opened in 1940. The cause? A 42 mph wind that caused the bridge deck to buckle and twist and finally break apart and fall into the water. During design of the bridge, to reduce costs, engineers had decided to stiffen the roadway with 8-foot girders instead of the original plan to use 25-foot supports. The bridge's collapse, which caused no loss of life, has been used as a lesson in civil and structural engineering classes ever since.

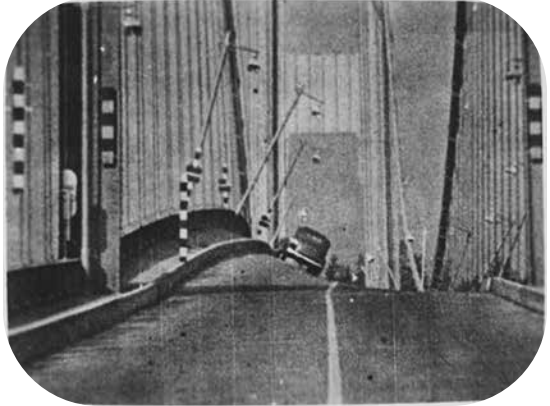

Tacoma Narrows Bridge collapse

Space Shuttle Challenger. The space shuttle Challenger broke apart 73 seconds after launch on January 28, 1986, killing all seven crew members onboard. The cause of the disaster was the failure of a seal, or O-shaped ring, at the joint of two parts of a solid rocket booster. Because of cold temperatures at launch, the ring was stiff rather than flexible, allowing hot gases and flames to blow out of the seal, destroying the shuttle's external fuel tank and causing the breakup of the spacecraft.

Hubble Space Telescope. The Hubble Space Telescope (HST) was launched into Earth's orbit in 1990. Situated far above Earth's soupy atmosphere, the HST was expected to deliver much clearer images than any telescope located on the ground. But as soon as astronomers looked at the first Hubble images, they knew something was drastically wrong. The pictures of deep space were blurry. The problem: The huge main mirror that the HST used to gather light from deep space had been ground to the wrong measurements. The result was blurry pictures. To correct the problem, NASA sent a repair team into orbit to fit the HST with corrective lenses that worked like eyeglasses to sharpen the focus. Since then, the Hubble has returned thousands of images of deep space that were never before possible.



Engineering as a Career

Let's look again at what engineers do. These statements may help you decide if you might like to become an engineer.

- Engineers apply the concepts and methods of science for the benefit of people.
- Engineers are creative, solve problems, and make decisions based on their solutions.
- Analyst engineers help the design engineers solve their most complicated problems, usually by applying complex mathematical methods, often using computers.
- Project engineers and systems engineers coordinate the work of a group of engineers, often from different fields, to complete a big, complex project.

All sorts of engineers work together on teams, which often include nonengineers as well (marketers, purchasers, manufacturers). Engineers also work alone, using their specialized skills to solve pieces of the team's problem. Though other people, such as factory workers or construction crews, actually make the things engineers design, engineers often make simplified models to better see how their ideas work together.



Many engineers (design engineers) dream up new things for people to use, and then figure out how to make them. When such an invention is a new and non-obvious solution to a problem, the government might recognize the engineer by granting a patent.

Do you like technology? One compelling reason to become an engineer is that they get to use the newest gadgets, most current computers, and most up-to-date software programs. As new technology emerges, interesting new engineering projects appear—everything from designing robotic spy planes to unraveling the mysteries of genetics to cure disease.



Other Things to Ask Yourself

You have read that engineers create new things to meet needs and solve problems. Do you enjoy doing the kinds of things engineers do? Ask yourself these questions.

- Do I try to figure out how things like toys, appliances, and machines at home work? Do I take them apart (with my parent or guardian's permission!) to see how they work? Can I put them back together without help?
- Do I like to try to fix household items that break, even though I may need help?
- Do I build or make things like roads and castles at the beach?
- Do I build things from model kits, sometimes customizing them by modifying the basic model and adding extra details?
- Do I use computer programs to solve special problems that interest me, or to create simple games?

Engineers use the principles of mathematics and science to do their work. Ask yourself:

- Do I do well in math in school? Do I enjoy it?
- Do I like science in school, especially the experiments?
- Do I do optional extra assignments the teachers give?
- Do I seek ways to use the ideas I learn in science?
- Have I ever entered a school science fair?

If you answered "yes" to some of these questions, then you may want to consider engineering as a career.

Are You Creative?

Creativity is the ability to bring new ideas or objects into being. It involves playing with imagination and possibilities, and seeing possible connections. Creativity is an ability that is vital to engineers, whether they design products, figure out how to analyze complicated parts, develop tests that determine how well things work, research new kinds of plastics, or figure out how to keep classes interesting for students. So if you like to question, explore, invent, discover, create, and help people solve problems and find new ways of doing things, then engineering may be for you.

Preparing for an Engineering Career

If you think you might like to become an engineer, then here are some things to start thinking about and doing now that will help you along the path to an engineering career.

Engineering College Entrance Requirements

Engineering colleges have entrance requirements—courses you must have taken in high school in order to be admitted to study engineering. Clearly, you will need math and science. It is best to take all the “college prep” math and science courses your high school offers. Don’t neglect English, either. Engineers must be able to clearly describe their work to others, from their bosses to the people who will build the things they design. You will also need to know what special tests they want you to take during high school, such as the Scholastic Aptitude Test (SAT).

Every college and university publishes a catalog that describes the school’s admission requirements and lists all its programs of study. Review the sections for the engineering fields (majors) that interest you. These will mention any special requirements or suggested courses.





If you are able to take electives during high school, you may want to consider courses that relate to the field of engineering that most interests you. Here are some examples.

- **Architectural engineering:** art, drafting
- **Bioengineering:** advanced biology, advanced chemistry
- **Chemical engineering:** advanced chemistry
- **Civil engineering:** art, drafting
- **Computer engineering:** advanced computers, electronics shop
- **Electrical engineering:** advanced computers, advanced physics, electronics shop
- **Materials engineering:** advanced chemistry, metal shop
- **Mechanical engineering:** advanced physics, automotive shop, drafting, metal shop
- **Software engineering:** advanced computers

The Professional Engineer

Engineering qualifies as a profession because it requires specialized knowledge and often long and intensive academic preparation. Engineers are also professionals because they make their living in an activity that conforms to the technical and ethical standards of a profession.

Ethics

Ethics are an important part of the engineering profession, especially as science and technology continue to evolve rapidly. An engineer's ethical standards are similar to those expected of other professionals in the well-established areas of medicine, business, and law.

Engineers have the responsibility to act ethically in the research and problem-solving part of their position as well as in dealing with the people directly affected by their work. Their work is for the good of the public and the clients they represent, and in no way should result in harm to people or the environment.

A Scout who commits to the Scout Oath and the Scout Law already has some understanding of ethics and is practicing them in his everyday life. These are the same principles that guide the careers of engineers and other professionals.

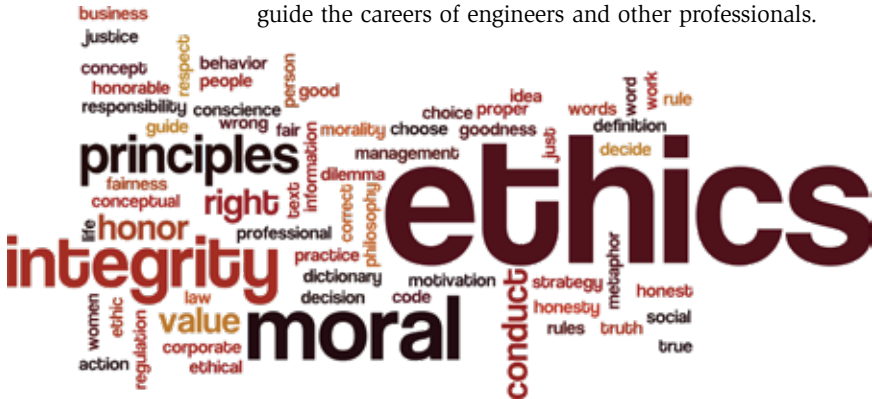

The Engineer's Code of Ethics has three fundamental principles that guide the work of the engineering profession. Engineers uphold and advance the integrity, honor, and dignity of their profession by

1. Using their knowledge and skill for the enhancement of human welfare
2. Being honest and impartial, and faithfully serving the public, their employers, and their clients
3. Striving to increase the competence and prestige of the engineering profession

Professional Registration

Qualified engineers may become licensed to practice engineering in their state. It isn't always necessary to get a Professional Engineering (PE) license to be hired as an engineer, but it may be required to perform certain governmental work and to review and approve designs. Some firms require engineers to be licensed before they can move up to engineering management positions.

Requirements vary from state to state, but for most engineers, obtaining a license is a four-step process. The applicant must:

1. Earn a four-year engineering degree in a program approved by the state engineering licensure board.
2. Complete four years of qualifying engineering work experience.
3. Pass the Fundamentals of Engineering exam. (Also called the Engineer-in-Training exam, this test can usually be taken by students in the final years of an undergraduate engineering curriculum, or any time after graduation.)
4. Pass the Principles and Practice of Engineering (PE) exam. The PE exam is hard, and it is not unusual for an applicant to fail it the first time (failed examinations may be retaken). The PE license must be renewed periodically.



Engineering Resources

Scouting Literature

Architecture, Automotive Maintenance, Chemistry, Composite Materials, Digital Technology, Drafting, Electricity, Electronics, Energy, Inventing, Model Design and Building, Nuclear Science, Programming, Robotics, Space Exploration, Surveying, and Welding merit badge pamphlets

With your parent or guardian's permission, visit Scouting America's official retail site, scoutshop.org, for a complete list of merit badge pamphlets and other helpful Scouting materials and supplies.

Books

Anderson, Margaret Jean. *Isaac Newton: The Greatest Scientist of All Time*. Enslow, 2001.

Baine, Celeste. *Is There an Engineer Inside You? A Comprehensive Guide to Career Decisions in Engineering*, 3rd ed. Professional Publications, 2004.

Berlow, Lawrence H. *Reference Guide to Famous Engineering Landmarks of the World: Bridges, Tunnels, Dams, Roads, and Other Structures*. Oryx, 1998.

Brown, Henry T. *507 Mechanical Movements: Mechanisms and Devices*. Dover Publications, 2005.

Dupre, Judith. *Bridges: A History of the World's Most Famous and Important Spans*. Black Dog & Leventhal, 1997.

Dupre, Judith. *Skyscrapers: A History of the World's Most Extraordinary Buildings*. Black Dog & Leventhal, 2013.

Freedman, Russell. *The Wright Brothers: How They Invented the Airplane*. Holiday House, 1994.

Garner, Geraldine O. *Careers in Engineering*, 2nd ed. McGraw-Hill, 2002.

Green, Constance McLaughlin. *Eli Whitney and the Birth of American Technology*. Addison Wesley Longman, 1997.

Hickam Jr., Homer H. *Rocket Boys (October Sky)*. Delacorte, 1998.

Kent, Steven. *The Ultimate History of Video Games: From Pong to Pokemon*. Prima Lifestyles, 2001.

Kuprenas, John, and Matthew Frederick. *101 Things I Learned in Engineering School*. Grand Central Publishing, 2013.

Middleton, William. *Landmarks on the Iron Road: Two Centuries of North American Railroad Engineering (Railroads Past and Present)*. Indiana University Press, 1999.

Molotch, Harvey. *Where Stuff Comes From: How Toasters, Toilets, Cars, Computers, and Many Other Things Come to Be as They Are*. Routledge, 2005.

Pletsch, William. *Integrated Circuits: Making the Miracle Chip*. Pletsch & Associates, 2000.

Reid, T.R. *The Chip*. Random House, 2001.

Roberts, Dustyn. *Making Things Move: DIY Mechanisms for Inventors, Hobbyists, and Artists*. McGraw-Hill, 2010.

Organizations and Websites

American Indian Science and Engineering Society

6321 Riverside Plaza Lane NW, Unit A
Albuquerque, NM 87120
Telephone: 505-765-1052
aises.org

**American Institute of
Chemical Engineers**

120 Wall St., 23rd floor
New York, NY 10005-4020
Toll-free telephone: 800-242-4363
aiche.org

American Society of Civil Engineers

1801 Alexander Bell Drive
Reston, VA 20191-4400
Toll-free telephone: 800-548-2723
asce.org

**ASME International (American
Society of Mechanical Engineers)**

2 Park Ave.
New York, NY 10016-5990
Toll-free telephone: 800-843-2763
asme.org

**Institute of Electrical and
Electronics Engineers**

3 Park Ave., 17th Floor
New York, NY 10016-5997
Telephone: 212-419-7900
ieee.org

Jet Propulsion Laboratory

4800 Oak Grove Drive
Pasadena, CA 91109
Telephone: 818-354-4321
jpl.nasa.gov

Kennedy Space Center

Space Commerce Way
Merritt Island, FL 32953
Toll-free Telephone: 855-433-4210
kennedyspacecenter.com

**National Action Council for
Minorities in Engineering**

440 Hamilton Ave., Suite 302
White Plains, NY 10601-1813
Telephone: 914-539-4010
nacme.org

**National Aeronautics and
Space Administration**

NASA Headquarters
Washington, DC 20546-0001
Telephone: 202-358-0001
nasa.gov

**National Action Council for
Minorities in Engineering**

nacme.org

National Society of Black Engineers

205 Daingerfield Road
Alexandria, VA 22314
Telephone: 703-549-2207
nsbe.org

**National Society of Professional
Engineers**

1420 King St.
Alexandria, VA 22314-2794
Toll-free Telephone: 888-285-6773
nspe.org

**Smithsonian National Air and
Space Museum**

Sixth and Independence Avenue, SW
Washington, DC 20560
Telephone: 202-633-2214
airandspace.si.edu

**Society of Hispanic
Professional Engineers**

Telephone: 323-725-3970
shpe.org

Society of Manufacturing Engineers

1000 Town Center, Suite 1910
Southfield, MI 48075
Telephone: 313-425-3000
sme.org

Society of Petroleum Engineers

Toll-free telephone: 800-456-6863
spe.org/en

Society of Women Engineers

130 East Randolph Street, Suite 3500
Chicago, IL 60601
Telephone: 312-596-5223
swe.org

Technology Student Association

Toll-free telephone: 888-860-9010
tsaweb.org

Acknowledgments

Scouting America is grateful to Scott S. Stuckey for updating this edition of the *Engineering* merit badge pamphlet. Mr. Stuckey is former managing editor at *National Geographic Traveler* magazine and is the former editor of *Boys' Life* (now called *Scout Life*) magazine.

Thanks also to the Convergence Education Foundation, whose members provided assistance with revising the *Engineering* merit badge requirements. The Foundation strives to expose young students to the wonders of science, mathematics, and engineering to pique their interest in a possible career for the future.

Scouting America is grateful to the men and women serving on the National Merit Badge Subcommittee for the improvements made in updating this pamphlet.

Photo and Illustration Credits

Boston Scientific Corporation, courtesy—cover (*pacemaker*) and page 37

Library of Congress, Prints and Photographs Division, courtesy—page 85

NASA, courtesy—page 38

Rehabilitation Institute of Chicago, courtesy—page 31 (*both*)

Segway Inc.; segway.com, courtesy—page 27

The Treehouse Guide, thetreehouseguide.com, courtesy—page 78

USDA Agricultural Research Service/Ken Hammond, courtesy—page 30 (*bottom*)

wikipedia.org, courtesy—pages 24 (*bottom*), 29 (*top*), and 57 (*top*)

All other photos and illustrations not mentioned above are the property of or are protected by Scouting America.

John McDearmon—pages 40 (*all*), 43, 48, 59 (*illustration*), 71 (*all*), and 80–81 (*illustrations*)

Brian Payne—page 55

Randy Piland—page 46

MERIT BADGE LIBRARY

Though intended as an aid to youth in Scouts BSA and qualified Venturers and Sea Scouts in meeting merit badge requirements, Scouting America's merit badge pamphlets are of general interest and are made available by many schools and public libraries.

Always check [scouting.org](https://www.scouting.org) for the latest merit badge requirements. If a Scout has already started working on a merit badge when new requirements for that merit badge are introduced, *they may continue to use the same pamphlet to earn the badge and fulfill the requirements therein*. In other words, the Scout need not start over again with the revised requirements.

American Business	Exploration	Plant Science
American Cultures	Family Life	Plumbing
American Heritage	Farm Mechanics	Pottery
American Indian Culture	Fingerprinting	Programming
American Labor	Fire Safety	Public Health
Animal Science	First Aid	Public Speaking
Animation	Fish & Wildlife Management	Pulp & Paper
Archaeology	Fishing	Radio
Archery	Fly-Fishing	Railroading
Architecture	Forestry	Reading
Art	Game Design	Reptile & Amphibian Study
Astronomy	Gardening	Rifle Shooting
Athletics	Genealogy	Robotics
Automotive Maintenance	Geocaching	Rowing
Aviation	Geology	Safety
Backpacking	Golf	Salesmanship
Basketry	Graphic Arts	Scholarship
Bird Study	Health Care Professions	Scouting Heritage
Bugling	Hiking	Scuba Diving
Camping	Home Repairs	Sculpture
Canoeing	Horsemanship	Search & Rescue
Chemistry	Insect Study	Shotgun Shooting
Chess	Inventing	Signs, Signals, Codes
Citizenship in the Community	Journalism	Skating
Citizenship in the Nation	Kayaking	Small-Boat Sailing
Citizenship in Society	Landscape Architecture	Snow Sports
Citizenship in the World	Law	Soil & Water Conservation
Climbing	Leatherwork	Space Exploration
Coin Collecting	Lifesaving	Sports
Collections	Mammal Study	Stamp Collecting
Communication	Metalwork	Surveying
Composite Materials	Mining in Society	Sustainability
Cooking	Model Design and Building	Swimming
Crime Prevention	Motorboating	Textile
Cycling	Moviemaking	Theater
Dentistry	Multisport	Traffic Safety
Digital Technology	Music	Truck Transportation
Disabilities Awareness	Nature	Veterinary Medicine
Dog Care	Nuclear Science	Water Sports
Drafting	Oceanography	Weather
Electricity	Orienteering	Welding
Electronics	Painting	Whitewater
Emergency Preparedness	Personal Fitness	Wilderness Survival
Energy	Personal Management	Wood Carving
Engineering	Pets	Woodwork
Entrepreneurship	Photography	
Environmental Science	Pioneering	

SCOUTING AMERICA

To place an order,
call **800-323-0736** or go to
[scoutshop.org](https://www.scoutshop.org)



EAGLE SCOUT



THE SUMMIT



SEA BASE

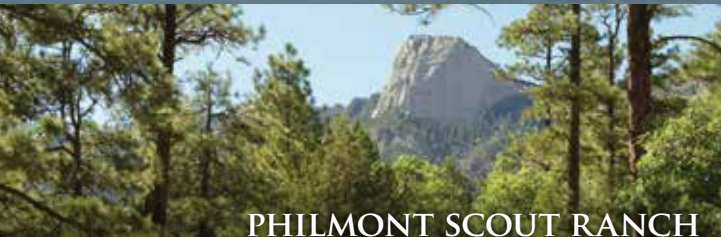

PHILMONT SCOUT RANCH



NORTHERN TIER

Discovery is at the heart of Scouting. We believe every adventure helps us uncover a little more about ourselves. Scouting builds the foundations for courage, resilience, and character, preparing youth for a lifetime of leadership. The path is yours to forge. Who knows what you'll discover?



ON THE ROAD TO
HIGH ADVENTURE

SKU 660201

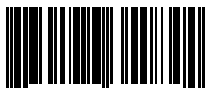

7 30176 35084 4
35890 2025 Printing



Certified Chain of Custody
At Least 30% Certified Forest Content
www.ofpprogram.org
SFI-C1042

